

PLAYERS GUIDE TO ELECTRONIC FOOTBALL GAMES

# electronic GAMES

Videogames • Computer Games • Stand-Alone Games • Arcades

October, 1982 • \$2.95

**EG'S 1983  
VIDEOGAME  
PREVIEW**

All the new systems!  
All the new games!

Customize Your  
Coleco Pac-Man

Videogame  
Hall of Fame

**STRATEGY  
SESSION:**

Chopper  
Command

Space Cavern

Freedom  
Fighter!

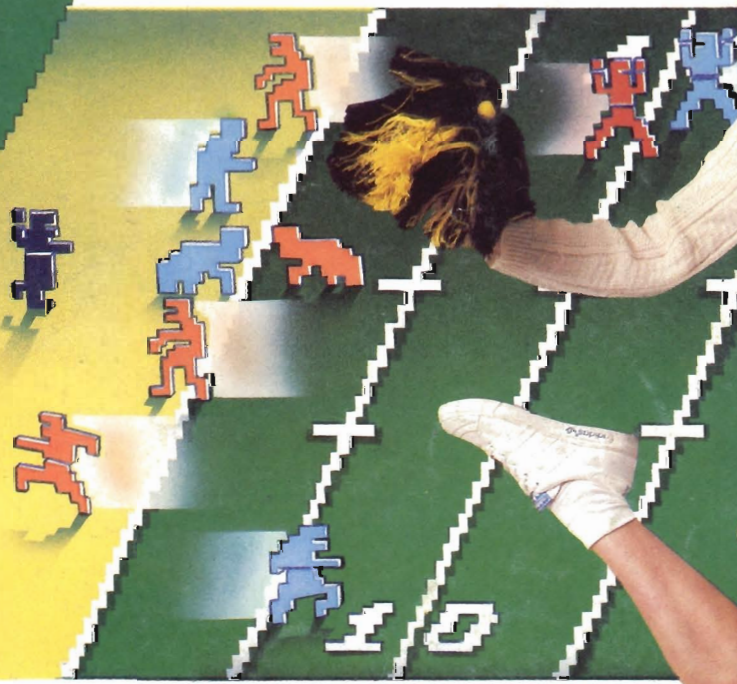

**HOME**  
**28** :00

**4TH**  
**01:12**



Retailers:  
See Page 78  
for Display  
Allowance  
Plan

DELL 04114



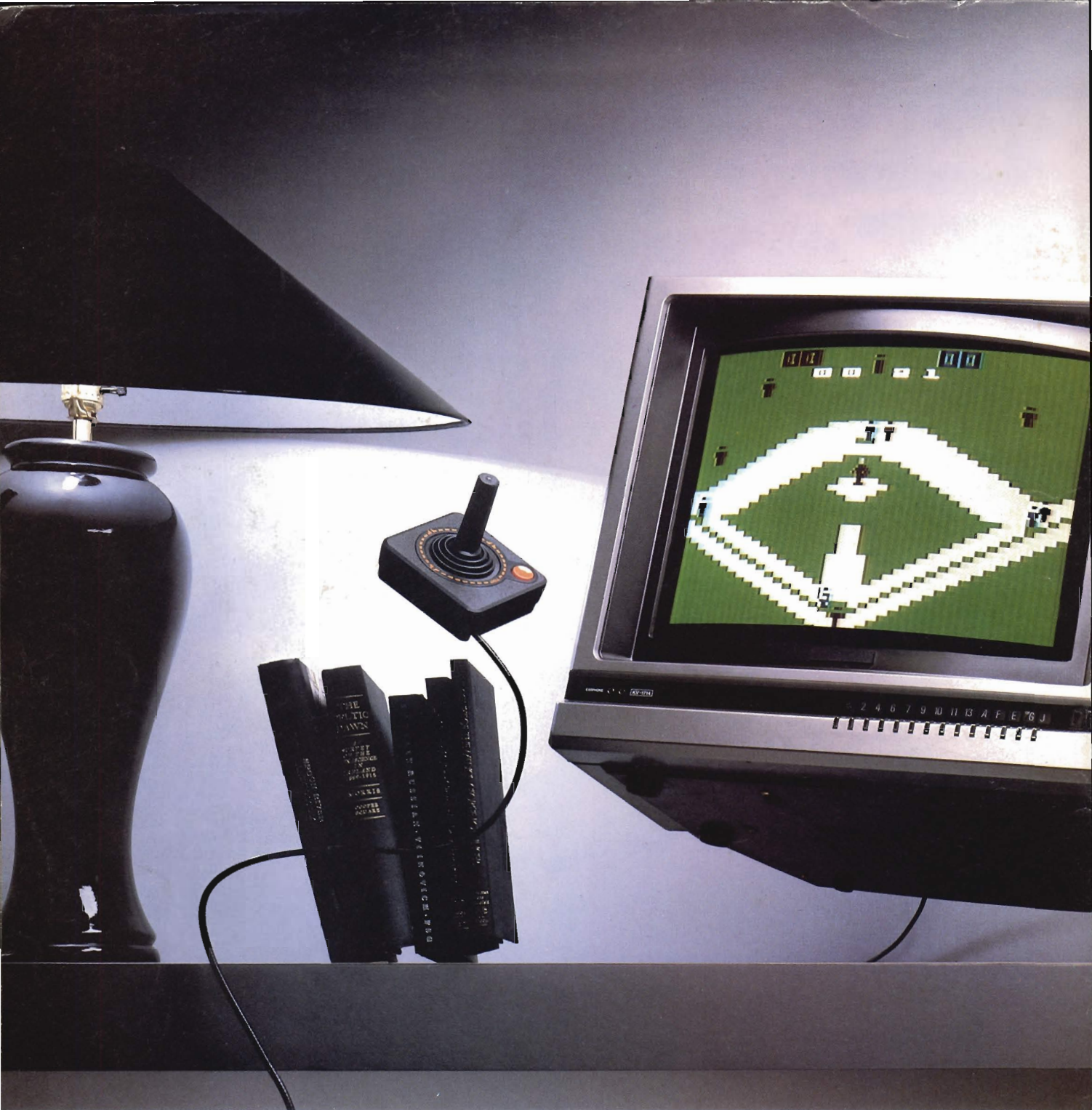

PHOTO BY STEIGMAN/BRONSTEIN

## **M NETWORK.™ THE VIDEO GAMES THAT HAVE A SUR**

*Our graphics don't move,  
they perform.*

*And our challenging game-  
play makes every performance  
spectacular.*

*Because M Network™ video  
games will now put new life in your  
Atari® VCS.*

*There's a library of M Network  
video games to choose from,*





**PRISING EFFECT ON YOUR ATARI® VCS.**

*and many more games to come.  
So, if you want to get more  
out of your Atari® VCS  
put our games into it.*



**NETWORK  
FROM MATTEL ELECTRONICS®**



Atari® is a trademark of Atari, Inc.

© Mattel, Inc. 1982. All rights reserved.  
\* Each sold separately. Some games not yet available.



Editor  
Arnie Katz

Executive Editor  
Bill Kunkel

Senior Editor  
Joyce Worley

Technical Director  
Henry B. Cohen

Strategy Editor  
Frank Tetro Jr.

West Coast Editor  
Les Paul Robley

Associate Editors  
Bill Heineman  
David Lustig

Contributing Editors  
C. Ross Chamberlain  
Leigh Goldstein  
Tom Hirschfeld  
Charlene Komar  
Roger Sharpe  
Captain Sticky  
Ken Uston

Editorial Assistant  
Lisa M. Honden

Art Director  
Ben Harvey

Graphic Consultants  
Creative Concepts

Los Angeles  
National Advertising Director  
6215 Rustling Oaks Drive  
Agoura, CA 91301  
(213) 873-3416

New York  
Advertising Manager  
Ann Martino  
235 Park Avenue South  
New York, NY 10003  
(212) 777-0800

Chicago  
Advertising Representative  
Milton Gerber  
2607 North Prindle  
Arlington Heights, IL 60004  
(312) 398-3032

Director of Retail Accounts  
Joseph Muccigrosso

Subscription Manager  
Rena Adler

Circulation Assistant  
Lynn Sheward

Publisher  
Jay Rosenfield

Co-Publisher  
Arnie Katz

Editorial Director  
Bruce Apar

Executive Advertising Director  
Bruce Mishkin

Production Manager  
Tom Koger

Circulation Director  
William D. Smith

Illustrators  
Mark & Stephanie Gerber  
Neil McPheeters  
Beirne Lowry  
Frank Emmi  
Bob Schochet  
Joe Williams  
David Febland

Photography  
Mitchell Charbo

Cover  
Charles Moll

4 Electronic Games

# electronic GAMES

SWITCH ON!.....	6	INSERT COIN HERE.....	49
		<i>Our verdict on the new coin-ops.</i>	
ELECTRONIC GAMES HOTLINE..	8	THE SPECIAL LOOK OF TRON	53
		<i>Find out how Disney Studios did those fabulous game sequences.</i>	
<b>FEATURE</b>		THE VIDEOGAME	
CUSTOMIZING COLECO'S	16	HALL OF FAME.....	58
PAC-MAN		<i>Which videogames have EG's readers voted into immortality?</i>	
<i>You can soup up your stand-alone Pac-Man in just a couple of hours!</i>		PROGRAMMABLE PARADE.....	60
		<i>The best - and worst - in new videogame cartridges.</i>	
Q&A.....	20	COMPUTER PLAYLAND.....	68
		<i>Our critics make sense of game software for microcomputers.</i>	
TEST LAB.....	24	INSIDE GAMING.....	74
<i>Our expert gets to the core of the Apple II computer system.</i>		<i>The truth about that designer-of-mystery, Mark "Sneakers" Turmell.</i>	
READERS REPLAY.....	28	JOYSTICK JURY.....	77
		<i>Our readers debate burning issues.</i>	
<b>SPECIAL FEATURE</b>		STRATEGY SESSION.....	80
ELECTRONIC GAMES' 1983		<i>Find out how to score higher at Space Jockey, Yar's Revenge and Mouskattack with these hints.</i>	
VIDEOGAME PREVIEW	32	ARCADE AMERICA.....	84
<i>There are more new cartridges than you can shake a joystick at.</i>		<i>A visit to a sunbelt game palace.</i>	
HOW TO CHEAT AT		GAMES LIBRARY.....	86
VIDEOGAMES.....	38	COIN-OP CLASSROOM.....	89
<i>A tongue-in-cheek guide to home arcading loopholes.</i>		<i>Make a monkey out of Donkey Kong!</i>	
<b>SPECIAL SECTION</b>		NEW PRODUCTS.....	92
THE PLAYERS GUIDE		PINBALL PALACE.....	95
TO ELECTRONIC		<i>Hot trend in flipper - and flipperless - games.</i>	
FOOTBALL GAMES	43	STAND-ALONE SCENE.....	99
<i>EG's magazine-within-a-magazine surveys the gridiron games.</i>		READER POLL.....	105

ELECTRONIC GAMES (ISSN 0730-6687) is published monthly by Reese Publishing Company, Inc., 235 Park Avenue South, New York, NY 10003. Application for mail at second-class postage rates pending at NY, NY and additional mailing office. © 1982 by Reese Publishing Company, Inc. All rights reserved. © under Universal, International and Pan American Copyright conventions. Reproduction of the editorial or pictorial content in any manner is prohibited. Single copy price, \$2.95. Subscription rates: one year (12 issues) \$28; two years (24 issues) \$48; Canada, one year \$32; foreign Air Mail only, one year \$64. Address subscription orders and correspondence to ELECTRONIC GAMES, P.O. Box 1128, Dover, NJ 07801. Change of address takes 60 days to process; send old address label, new address and zip code. All material listed in this magazine is subject to manufacturer's change without notice, and publisher assumes no responsibility for such changes. Printed in the U.S.A.

POSTMASTER: Send form 3579 to ELECTRONIC GAMES, P.O. Box 1128, Dover, NJ 07801.

Spiderman, the Hulk and the X-Men are all Copyright © 1982 by Marvel Comics Group, a Division of Cadence Industries Corporation. All rights reserved.



**You have journeyed far...  
Your starship has landed...  
Your adventure has just begun.**

**SPACE CAVERN™**

VIDEO GAME  
TO BE USED WITH  
JOYSTICK CONTROLLERS  
WITH THE  
Video Computer System™ by Atari  
and  
The Sears Tele-games System™

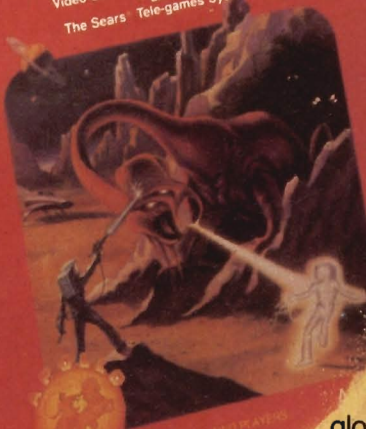

16 CARTRIDGES FOR ONE OR TWO PLAYERS  
**GAMES BY APOLLO™**

You've conquered space, blasting through the asteroid belts, annihilating every obstacle. Now you're there—the misty caverns of Zenon—ready to face the greatest challenge of all. Winged Electrosauri swoop down from above, firing deadly blasts of electromolecular energy. The dread Marsupods lie in wait. One touch of their hideous tentacles can turn you into a glowing skeleton. If you've done well at lesser games, then you may be ready for SPACE CAVERN™. But beware...

SPACE CAVERN™ from GAMES BY APOLLO.  
For use with the Atari® 2600 Video Computer System™.

**GAMES BY APOLLO, INC.**

1300 E. Arapaho Road  
Richardson, Texas 75081

Atari® and Video Computer System™ are trademarks of Atari, Inc.





# SWITCH ON

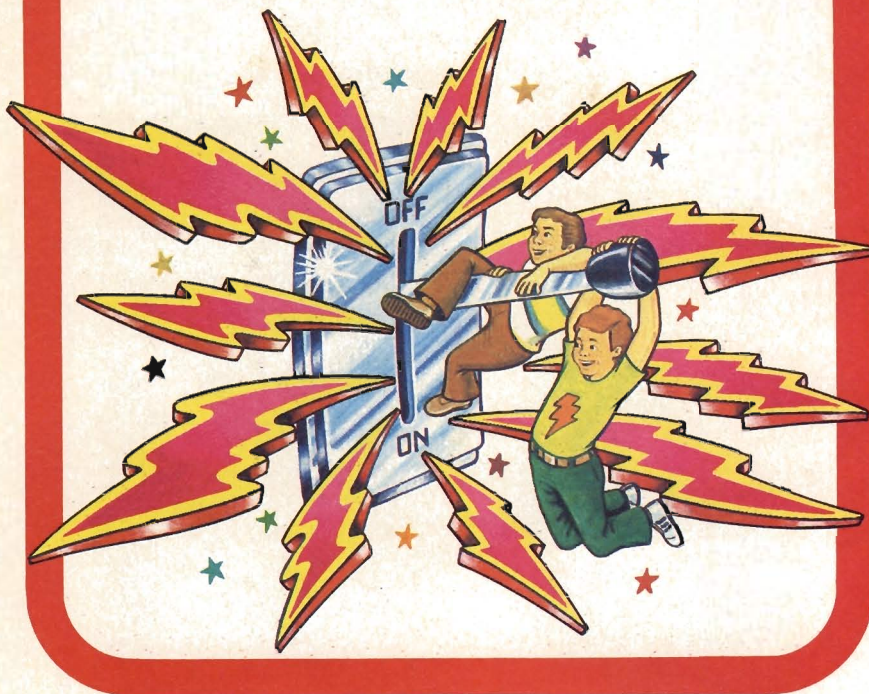

## No Knockoffs!

By ARNIE KATZ

It was well over a year ago, back when everyone in the electronic gaming world still knew me as "Frank Laney Jr." that I encountered my first knock-off coin-op machine.

Magazine writers, at least those who have to prowl the field for fresh stories, generally end up spending a lot of time waiting around in airports. A scheduled plane konks out or unscheduled fog rolls in and—presto!—you're waiting two or three hours until the new departure time.

Waiting can be pretty gruesome even in a large, shop-filled terminal. The hours can creep past with arthritic slowness when a delay strands you at a small field.

I noticed a small knot of people in the back of the dimly lit bar almost as soon as I heard the familiar "wakka-wakka-wakka" issuing from their midst. As my eyes became accustomed to the darkness, I saw that three people were huddled around a cabaret model of a videogame. Two stewardesses and a youngish guy in an airlines uniform were taking turns feeding quarters into the machine.

From the sounds of frustration that drifted across the small room to my perch at the end of the bar, none of them were likely to pose a threat to Bill Heineman or Frank Tetro as arcade aces.

I'm not going to frighten either of these super-gamers, either, but constant exposure to the games and a fair bit of practice have made me more

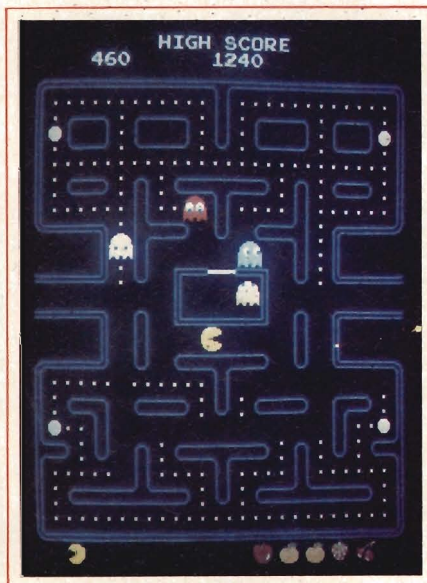

PAC-MAN PLAYFIELD

than a match for the average arcader. So I was pretty confident when I sauntered over to where they were playing, jingled the coins in my pocket with undeniable *savoir faire*, and asked if I could join the informal little competition.

I don't know if it was the look of determination in my eye or the copy of the first issue of **Electronic Games** tucked under my arm, but they not only invited me to play, but they insisted I should take my turn immediately.

"I love these maze-chase games," I chuckled as I gripped the control stick and began to move the little gobbler around a playfield that somehow didn't seem quite right.

Of course, those extra scrolling tunnels should have warned me. I had barely begun the first round when a goblin that roared through the corridors like it was jet-propelled, barrelled right into my defenseless muncher.

The second "life" wasn't much better. I turned the southwest corner and—no power pill! As my hand hesitated on the lever, the goblins quickly surrounded and dispatched my on-screen surrogate.

As the third round began, I located one of the pulsating energizers and made a bee-line for it. The four goblins lined up behind me, just the way Ken Uston promised they would. I ate the pill and quickly reversed direction, anxious to turn the tables and gobble up a batch of bonus points. The meanies flashed blue once, twice and then—they were back to normal in time to deflate my final gobbler before it could eat even the one directly on its heels!

I don't know whether the machine's nearly indecipherable lettering read "Pick-man", "Puc-man" or "Park-man", but I do know that that was the day I decided that no knock-off machine would ever get another quarter from me.

Knock-offs don't just hurt the manufacturer of the original game, they are bad for the arcaders, too. Almost invariably, the knock-off machine will be a super-tough version of the real thing that simply doesn't give the gamer a fair chance to demonstrate his or her skill.

So I don't mess around with unknown quantities. If I don't see the real coin-op machines, I pour my change back into my pocket and go elsewhere.

Let's save our precious quarters for the genuine article, not a cut-rate copy!



# SPECTRAVISION™



## Meet the Challenge..!

Brace yourself for the Video Game Challenge of a lifetime . . . Spectravision dares you to: Shoot-it-out with Mugsy, Scarface, Shifty, Lefty, and the deadly Nitro Ed in **"Gangster Alley"**™  
 Destroy all alien bases and rescue your comrades in **"Planet Patrol"**™

Conquer evil forces with your Spectron . . . while being attacked by Marpods from planet "Tzoris" in **"Cross Fire"**™

Escape the inevitable radioactive particles from a damaged nuclear power plant in **"China Syndrome"**™

Direct the amusing Slinky, the "Spectraworm" . . . ever-growing and under attack from Beeky and Spanky—in **"Tapeworm"**™  
 You'll thrill at the challenges that lie before you with Spectravision Video Games—

- More Colorful Graphics
- Multi-Skill Levels
- Extraordinary Action and Challenge!

Spectravision Video Games fit Atari® Game Systems and Sears Video Arcade.

Spectravision . . . Our Games Come to Life!



Gangster Alley™



Planet Patrol™



Cross Fire™

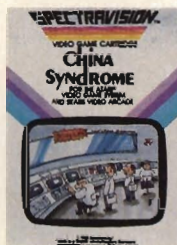

China Syndrome™



Tapeworm™

# SPECTRAVISION™



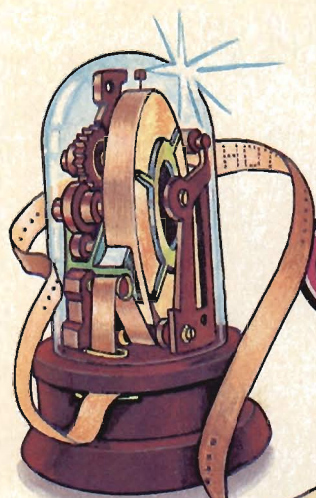

# ELECTRONIC GAMES HOTLINE

Dyas

## ACTIVISION CLOSE-UP

★ Already the leading independent producer of game software for the Atari VCS, the folks at Activision have strengthened their grip on the marketplace by adding five new designers and opening an east coast creative design division in New Jersey.

In addition to Kevin Kalkut, John Van Ryzin and Paul Wilson, Activision picked up a pair of extremely promising game rookies, the Kitchen Brothers, Dan and Garry. The Kitchen boys were involved in the development of both Coleco's *Donkey Kong* and *Space Jockey* for U.S. Games/Vidtec.

The balance of talents in this mixture of creative personnel indicates a continuing of the quality product Activision has built its reputation upon.

★ Meanwhile, one of the "Gang of Four" ex-Atari designers who comprised the

original Activision team, with founder Jim Levy, has left the company. Larry Kaplan designed both the first 4K Activision cartridge, *Bridge*, and one of Activision's most popular titles, *Kaboom!*

★ Co-sponsoring the event with Franklin Music, L. Robert Benjamin & Associates and local radio station WKLS, Activision held the Official Georgia Championships for *Kaboom!* and *Stampede*. Beginning April 17th and running through the 25th, the preliminaries were a rousing success, with 16 finalists going on to the Perimeter Mall in North Atlanta to slug it out for State honors.

The winners were Tony Brooks for *Kaboom!* (logging over 10,000 points) and Phil Pearce at *Stampede* (roping 22,000 plus points). Congratulations all!

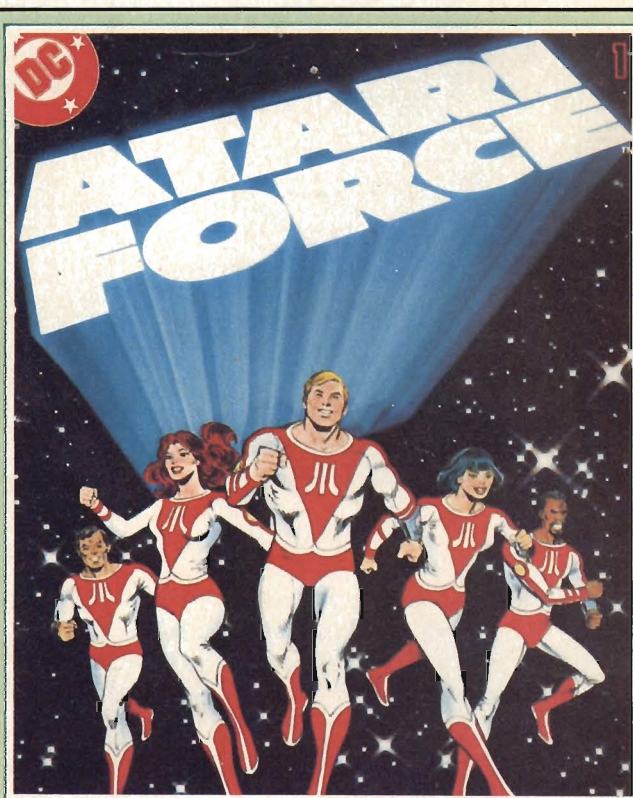
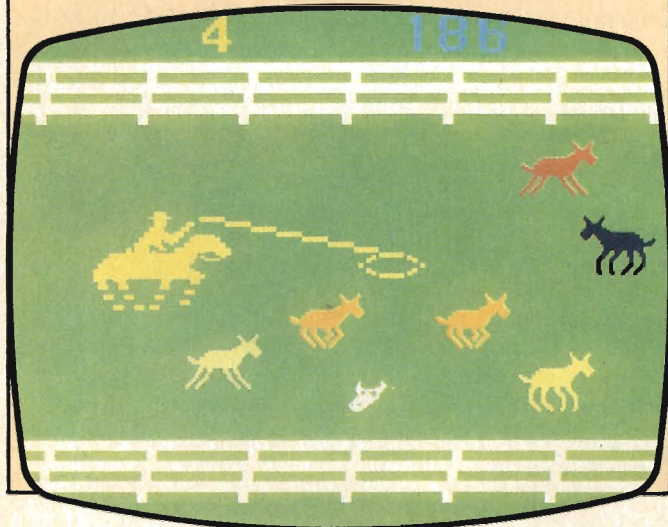

## THE COMING OF... THE ATARI FORCE

If Superman, Conan and Spiderman can make the transition from comic books to home videogame cartridges, why shouldn't an equally famous name in the electronic gaming field make it big in the world of four-color panels? According to DC Comics and Atari, there's no reason at all.

Specially marked Atari VCS cartridge packages are including the first issue of a pocket-size full-color 48-page comic book starring the Atari

Force. This futuristic adventure strip is written by DC heavies Gerry Conway and Roy Thoma, with illustration by Ross Andru, Dick Giordano and Mike Decarlo.

The Atari Force will soon be rocketing toward new exploits in the science fiction world of 2,005 A.D. The second edition will be distributed along with Atari's much-anticipated *Berzerk* VCS cartridge, and a third is already planned to accompany the VCS *Star Raiders*.



## TRON: A DREAM COME TRUE

By ARNIE KATZ

It's hard to imagine someone who could love videogames and not also love Disney Productions' *Tron*. The question of whether or not to recommend this science fantasy extravaganza simply never arises. No one who regularly reads **Electronic Games** could possibly restrain themselves from rushing down to their local theater to see this movie.

The strength of *Tron* is that it takes the wish-dreams of the nation's arcaders and gives them form and substance. According to the film's interior logic, Flynn actually enters an alternate reality inside the computer when the MCP zaps him during the attempted break-in. Yet that reality is, in fact, the stuff of fantasy, the kinds of things many gamers might be thinking about when the electronic action gets hot and heavy. Seeing these head-trips blazing across the

big screen has to be a profound experience for any hard-core electronic gamer.

Reams have been—and will be—written about the magnificent special effects which illuminate and energize *Tron*. All the flash should not, however, obscure the fact that this may well be the best Disney movie since the studio was turning out gems like *Sleeping Beauty*. While it is far from perfect, *Tron* has better acting and plotting than any Disney production done in the last decade. Bruce Boxleitner (*Tron*), Jeff Bridges (Flynn) and David Warner (Dillinger) are effective and convincing. Barnard Hughes once more proves quite adept at playing a Barnard-Hughes-type of character, and Cindy Morgan is at the very least less objectionable than the usual Disney heroine.

In fact, Morgan's persona inside the computer, Yuri, is

exactly the sort of ultra-bland women who has become all too familiar in Disney's life-action "comedies". The heavy dramatic scenes involving her are some of the poorest moments in the movie.

The single worst defect in *Tron* is the abominable editing. It is especially horrendous in the solar sailor sequence. For instance, much is made of the dangerous grid spiders, but they never figure directly in the plot. It would've been an even better movie had it been perhaps 10-15 minutes longer.

Those who enter the theater expecting profound philosophy from *Tron* are headed for a disappointment. Those who crave a science fantasy to rank with such other mega-hits as *Star Wars*, *The Empire Strikes Back*, *Superman I* and *Raiders of the Lost Ark* have come to the right place.

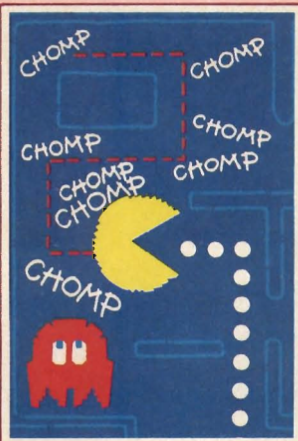

Here's a greeting card that's fit for your favorite pac-maniac.

### PAC-MANIA STRIKES HALLMARK CARDS

Score another major coup for Pac-Man, which is already the most easily recognized visual symbol in America. The latest development in the gallant gobbler's career is that Hallmark has installed *Pac-Man* departments in its chain of card shops and stocked it with all manner of *Pac-Man*-inspired goodies.

Among the products featured are a selection of colorful seals which can be used to give packages, notebooks and such that gaming look. Another hot item is the *Pac-Man* birthday card, which, characteristically, has a large bite taken out of it.

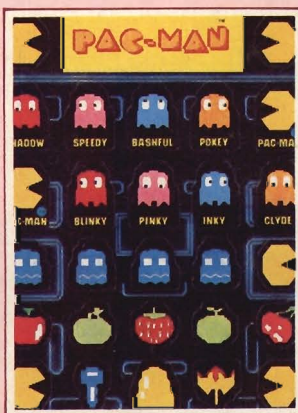

These Pac-Man stickers will liven up anyone's correspondence.

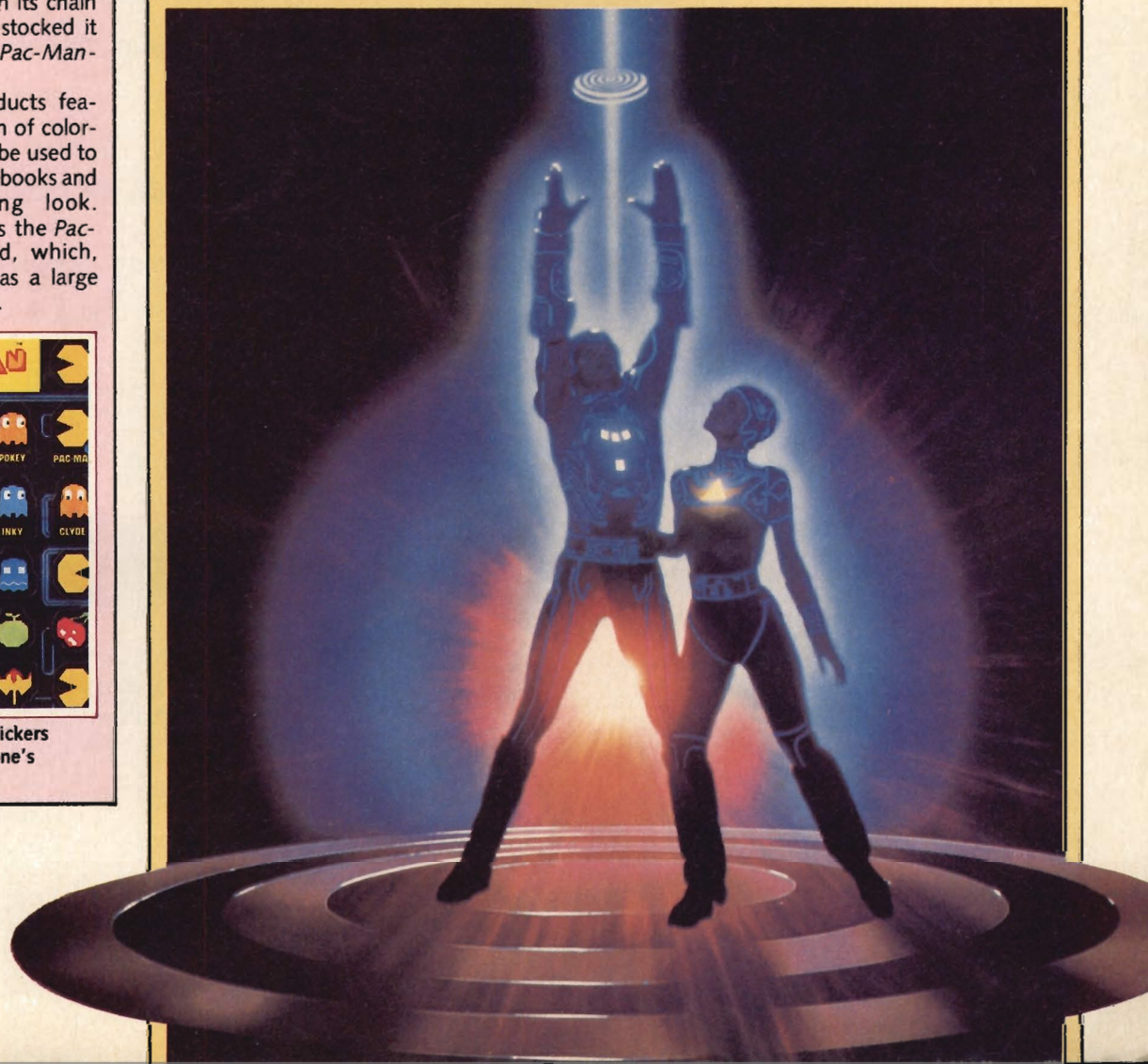



## THE CAT'S MEOW

Two major coin-op games that have raked in a lot of quarters over the last year or so are now available in stand-alone format, courtesy of Bandai Electronics. The company plans to have both *Crazy Climber* and *Frisky Tom* into stores in time for the holiday gift-buying season.

Bandai is also moving forward on other fronts. The most unusual of the products are a pair of solar powered hand-helds. They'll even work indoors next to a light bulb or candle, if the weather is not good enough to go outside into the sunshine.

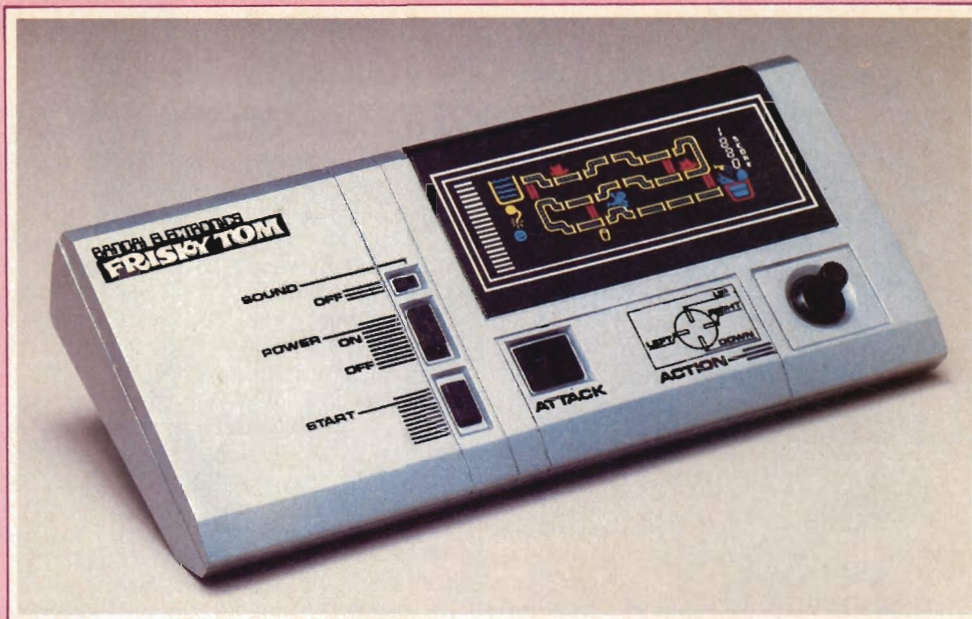

## ★ THE NATIONAL ★

# ARCADE SCOREBOARD

## THE BEST SCORES FOR POPULAR VIDEOGAMES

Photos of readers' best scores are really pouring into the offices of *Electronic Games*, and the competition among the land's arcade aces is even keener than expected. There are plenty of top players out there, and the rankings listed here show that they're hitting the joystick hot and heavy in a bid for national recognition.

The scores tabulated here reflect the first group of games which the editors of *EG* selected to kick off this continuing compilation of home videogaming records. We'll be adding more games each month, a few at a time, until we're covering most of what's hot!

To have your gaming achievements recognized in the National Arcade Scoreboard, all you've got to do is follow a few simple rules:

1. Every score must be accompanied by a photograph of the TV screen showing the score. These photos do not have to be of publishable quality, just readable by our judges.
2. All photographs received become the property of *Electronic Games* and none can be returned.
3. Be sure to include your complete name and address. (We will print only the name and city in the magazine, but we may want to contact high scorers for helpful gaming hints.)

Games currently eligible for the National Arcade Scoreboard are:

- ★ **UFO** (Odyssey)
  - ★ **Asteroids** (Atari VCS) — Game #6
  - ★ **Grand Prix** (Activision) — Game #4
  - ★ **USAC Auto Racing** (Mattel) — Course #1
  - ★ **Galactic Invasion** (Astrocade) — Difficulty #1
  - ★ **Spacechase** (Apollo) — Game #1
- New additions to the list this month are:
- ★ **Defender** (Atari VCS) — Game #1

- ★ **The Incredible Wizard** (Astrocade) — One player, Easy Difficulty
- ★ **Space Hawk** (Mattel) — Game #1 (Auto-fire is desired)
- ★ **Pac-Man** (Atari VCS) — Game #1

## THE HONOR ROLL

### UFO/Odyssey/Odyssey<sup>2</sup>/Game #1

1. **1,636** — Lee Raymond, no address given
2. **1,575** — Jim Peterson, Farmington Hills, Mich.
3. **1,461** — Marlon Burns, Chicago, Ill.
4. **1,157** — Shawn Peters, American Fork, Ut.

### Asteroids/Atari/Atari VCS/Game #6

1. **199,930** — Edward Semrad, Waukesha, Wis.
2. **129,460** — Robert Prindle, Erie, Pa.
3. **114,130** — Steven Zadra, Fairbanks, Alaska

### Grand Prix/Activision/Atari VCS-Course #4

1. **1:14:39** — Mike Ratledge, Charleston, S.C.
2. **1:42:12** — Mark Martell, Brooklyn, N.Y.
3. **1:49:34** — Bong Nguyen, Santa Ana, Ca.

### USAC Auto Racing/Mattel/Intellivision/Course #1

1. **2:58** — John Bunk, Johnstown, Pa.
2. **2:59** — Donald Smith, Pease AFB, N.H.
3. **3:02** — Don Gaze, Willowdale, Ontario, Can.

### Galactic Invasion/Astrocade/Astrocade/Difficulty #1

1. **99,999** — Steve Sabolich, no address given.

### Spacechase/Apollo/Atari VCS/Game #1

1. **38,500** — Bill Kunkel, Kew Gardens, N.Y.





SYNCRO Software for ATARI™ 400/800 HOME COMPUTER.

Now from SYNCRO, the people who brought you  
*Mar Tesoro, Drac is Back, Alien Hell and Maze of Death. . .*

## ASTRON IV ©1982

An all graphic adventure game for the Atari\* 400/800\*  
Home Computer. 16K Cassette 24K Disk

As space warriors of the galaxy you penetrate ASTRON IV® to destroy the pirate asteroid. You battle several types of robots and the deadly ORBITRON with your space vehicle equipped with Z-bolts. You must penetrate four levels of the asteroid destroying the power panels that control the enemy's power. Once the panels are destroyed you must then escape. You may even battle each other for control.

### FEATURES

Programmed in Hybrid Basic for fast action.	
One or two players.	Power stations
Automatic scoring	Joystick operated
Bonus Points	All Color

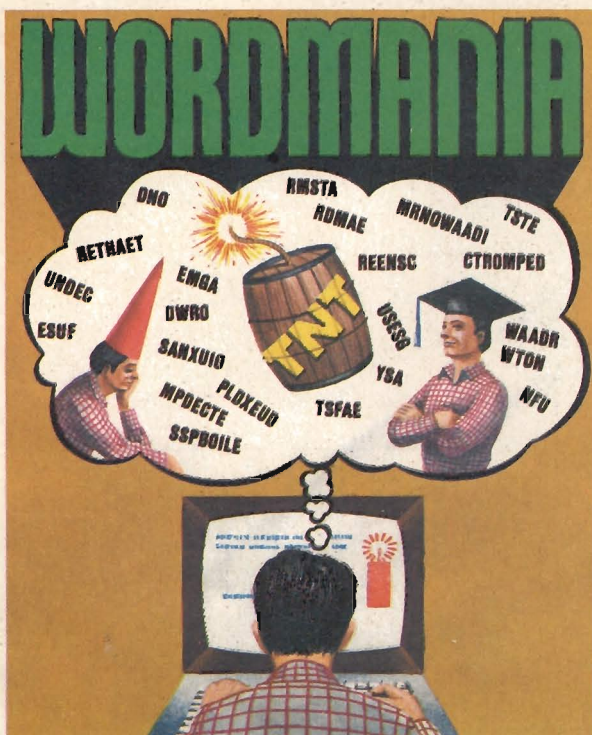
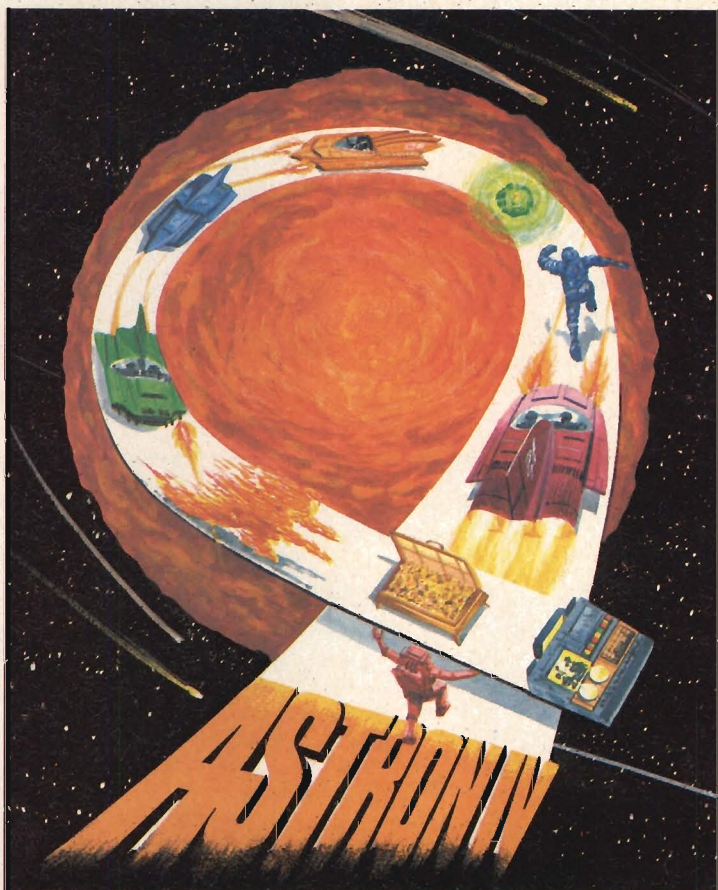

Wordmania ©1982 is a challenging word game with many unique features.

Players may compete individually or in the two player mode. This program has been developed for ages 5 through adult and will offer a challenge even to the most skilled player.

Wordmania ©1982 has been developed as an educational program in several respects, to improve typing abilities, word recognition, spelling, concentration and make learning fun.

Wordmania ©1982 16 K Cassette 24 K Disk

\*Indicates Trademark of Atari, Inc.

Coming Soon . . .

LASER ANTS ©1982  
and ASTRON IX ©1982



SYNCRO, INC.  
SOFTWARE DIVISION  
30941 W. Agoura Road, Suite 200  
Westlake Village, Calif. 91361  
(213) 889-9508

ORDER FROM YOUR FAVORITE DEALER OR YOU MAY ORDER DIRECT FROM SYNCRO, INC.  
ADD \$2.00 FOR SHIPPING AND HANDLING — CALIF. RESIDENTS ADD 6½% SALES TAX.



## ATARI AIDS SPECIAL ATHLETES

Earlier this summer, Atari helped some of life's less fortunate youngsters by participating in the California State Special Olympics (geared specifically to the autistic). The videogame giant contributed coin-op machines and life-sized videogame characters to the festivities.

Atari's *Dig Dug*, *Pac-Man* and other videogame characters marched in the opening parade, as participants lit and carried the Olympic torch.



Atari gave some less fortunate kids a chance to play.

Even Matthew Laborteaux, more commonly known as Albert Ingels from NBC's "Little House on the Prairie", assisted at the Atari booth, helping athletes hone their zapping skills.

Laborteaux, in addition to being an avid videogamer, is particularly sympathetic to the Special Olympic's Superheroes—he is also an autistic child.

Don Osborne, V.P. in charge of the Coin Video Division, presented a whopping \$2,500.00 donation to the Special Olympics Committee, on behalf of the company.

# THE NATIONAL VANITY BOARD

## Today's Top Coin-op Scores

Electronic Games is proud to announce the creation of the National Vanity Board to identify and honor the nation's arcade aces. Just as the National Home Arcade (set to debut next month) salutes the achievements of the lords and ladies of livingroom gaming, the National Vanity Board will monitor the triumphs of the kings and queens of the coin-op videogaming world.

EG will update the listings each month based on information provided by game manufacturers, arcade operators and, most importantly, our hundreds of thousands of readers. If you or one of your buddies rewrites the record book for the most popular commercial arcade machines, getting the proper recognition for the new champ is as easy as following these three steps:

1. Set the record.
2. Show the arcade manager on duty your record score and have him (or her) sign the proper portion of the report form—copies or facsimiles are fine.
3. Mail your score report to: Electronic Games, 235 Park Avenue South, Sixth Floor, New York, N.Y. 10003.

### Score Report Form

Name of Player (Please Print) \_\_\_\_\_

Player's Address \_\_\_\_\_

Name of Game \_\_\_\_\_

Score \_\_\_\_\_

Name of Arcade \_\_\_\_\_

Arcade Address \_\_\_\_\_

Arcade Operator's Signature \_\_\_\_\_

## Here Are the Arcaders to Beat!

**Astro Blaster (Sega Gremlin)**  
Phil Iati  
Lakewood, Ca.  
Record: 64,610

**Star Castle (Cinematronics)**  
Sterling Ouchi  
Torrence, Ca.  
Record: 7,105,000

**Missile Command (Atari)**  
Joe Fernandes  
Artesia, Ca.  
Record: 52,246,260

**Crazy Climber (Taito)**  
John Shadrick  
Los Alamitos, Ca.  
Record: 320,750

**Centipede (Atari)**  
Sterling Ouchi  
Torrence, Ca.  
Record: 3,058,437

**Defender (Williams)**  
Joe Dearman  
Cerritos, Ca.  
Record: 24,630,495

### BATTLEZONE

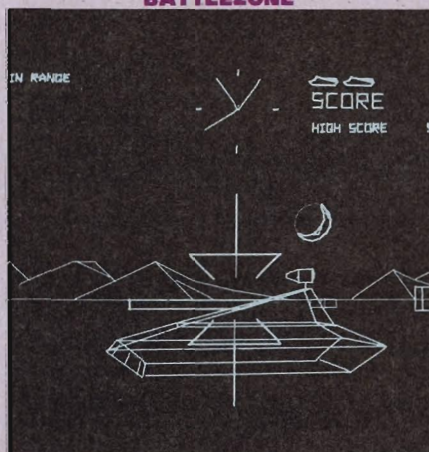

**Phoenix (Centuri)**  
Keith Wade  
Lakewood, Ca.  
Record: 312,355

**Scramble (Stern)**  
Matt Wheeler  
Buffalo, N.Y.  
Record: 366,030

**Battlezone (Atari)**  
Mike Johnston  
Los Alamitos, Ca.  
Record: 5,899,000

**Pac-Man (Midway)**  
Paul Pedrian  
Cypress, Ca.  
Record: 5,579,350

**Ms. Pac-Man (Midway)**  
**Armor Attack (Cinematronics)**  
John Hooper  
Lakewood, Ca.  
Record: 319,670

**Gorf (Midway)**  
John Chandler  
Hobbs, N.M.  
Record: 225,100

**Dig Dug (Atari)**  
Peter Fanning  
Indianapolis, Ind.  
Record: 846,840



Zaxxon's TV commercial is a first for coin-ops.



### ZAXXON TAKES TO THE AIR

**Zaxxon**, Sega/Gremlin's space combat game, caused quite a sensation when it first saw the light of day in the commercial arcades. The unorthodox perspective and super-detailed graphics were a much-welcomed breath of fresh air. Some players so love the look of this machine that they hardly even mind getting wiped out even in the opening, sky fortress scenario of the three-part contest.

Now **Zaxxon's** dynamic visuals are thrilling millions of people who've never had the pleasure of encountering it. In what is believed to be a first in the coin-op game field, Sega is advertising its smash hit title on national television. The commercials, which stress the game's undeniably high level of excitement, are also intended to make the public more familiar with the Sega/Gremlin brandname.

### DEFENDER GRABS TOP SPOT

**Pac-Man's** two-month reign as the world's most popular videogame has ended, but it took the arrival of another Atari-created translation from the coin-op world to topple the gobble game from its perch **Defender** jumped to the head of the line in its very first month of eligibility, with **Pac-Man** sliding down a notch to second place.

Making a strong comeback this month is Mattel's **Astro-**

expanded to a "top 15" last issue instead of this month.

As predicted here, Atari's ROM cartridge of **Pac-Man** for its 400 and 800 computer systems has become an instant hit. This home edition, which many feel is the closest approach to the coin-op original, landed in fifth place. Also new on the list are a couple of action games from On-Line Systems—**Mouskattack** and **Crossfire**, both of which are available for play on the Apple and Atari microcomputers.

Sometimes, you've got to fall before you can rise to ultimate triumph. That's clearly the case with **Tempest**. After dropping several positions last month, Atari's color quadrascan entry vaulted right into the number one slot, while former champion **Pac-Man** slipped back to fifth.

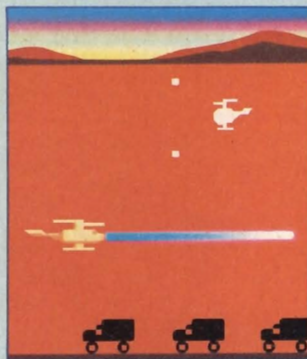

CHOPPER COMMAND

**smash**. After falling off the top ten list in September, this arcade-style Intellivision cartridge zoomed right back into the fifth position. Perhaps this title's many partisans were too busy watching for spinners last month to send in their ballots.

Other videogames making an appearance for the first time are **Yars' Revenge**, **Starmaster**, **Chopper Command**, and **Star Strike**. Actually, both **Yars'** and **Star Strike** would've made it last time, if we had

The gobble game mania hasn't died yet, however. Though **Pac-Man** isn't the most popular arcade machine any more, **Ms. Pac-Man** has now joined it in the "top 10" standings. In fact, combing votes for both games would have resulted in a second-place rating.

A similar case involves Williams' **Defender** and its sequel, **Stargate**. Although the former fell to the ninth spot, the latter made up the slack by entering the list. Adding ballots cast for both together would have put one or the other into fourth place.

### TOMYTRONICS UNVEILS TRON

The newest entry in Tomytronics growing line of mini-arcade machines is the first **Tron**-themed game to reach the retail market. (Midway, of course, beat everyone to the punch with its **Tron** coin-op.)

It's quite a mighty little machine, too, with action that includes **Tron**, **Sark**, light cycles and the nefarious Master Computer Program.

Tomy expects to be shipping its **Tron** stand-alone by the time this issue of **Electronic Games** magazine reaches the newsstands.





# E.G. READERS PICK THEIR FAVORITE GAMES

## ☆ Most Popular Videogame Cartridges ☆

Position		Game	System	Manufacturer
This Month	Last Month			
1	—	Defender	Atari VCS	Atari
2	1	Pac-Man	Atari VCS	Atari
3	4	Demon Attack	Atari VCS	Imagic
4	3	Adventure	Atari VCS	Atari
5	—	Astrosplash	Intellivision	Mattel
6	—	Yars' Revenge	Atari VCS	Atari
7	—	Starmaster	Atari VCS	Activision
8	2	Missile Command	Atari VCS	Atari
9	8	Major League Baseball	Intellivision	Mattel
10	10	K.C. Munchkin	Odyssey <sup>2</sup>	Odyssey
11	5	Grand Prix	Atari VCS	Activision
12	—	Chopper Command	Atari VCS	Activision
13	—	Star Strike	Intellivision	Mattel
14	—	Quest for the Rings	Odyssey <sup>2</sup>	Odyssey
15	—	UFO	Odyssey <sup>2</sup>	Odyssey

## ☆ Most Popular Computer Programs ☆

Position		Game	System	Manufacturer
This Month	Last Month			
1	1	Star Raiders	Atari 400/800	Atari
2	2	Missile Command	Atari 400/800	Atari
3	3	Jawbreaker	Atari 400/800	On-Line
4	7	Castle Wolfenstein	Apple II	Muse
5	—	Pac-Man	Atari 400/800	Atari
6	8	Empire of the Over-Mind	Atari, Apple II, TRS-80	Avalon Hill
7	10	Wizardry	Apple II	Sir-Tech
8	—	Crossfire	Apple II, Atari 400/800	On-Line
9	5	K-razy Shoot-out	Atari 400/800	K-Byte
10	—	Mouskattack	Apple II, Atari 400/800	On-Line

## ☆ Most Popular Coin-Op Videogames ☆

Position		Game	Manufacturer
This Month	Last Month		
1	5	Tempest	Atari
2	2	Donkey Kong	Nintendo
3	—	Zaxxon	Sega/Gremlin
4	1	Pac-Man	Namco/Midway
5	—	Ms. Pac-Man	Midway
6	6	Centipede	Atari
7	—	Scramble	Stern
8	8	Star Gate	Williams
9	2	Defender	Williams
10	—	Galaga	Midway

### Readers Choose Top Games

Since mere *quantity* of play doesn't necessarily equal actual popularity, **Electronic Games** bases its standings on the votes of its readers. These lists of most popular games are based on the more than 800 Reader Polls. We update the "picked hits" lists in every issue of **Electronic Games**.

So send in your votes!

## "DEFEND ATLANTIS" OFFICIAL CONTEST RULES

1. To enter, print your name, address and phone number on an official entry form or on a 3 by 5 piece of paper and mail to:

"Defend Atlantis," P.O. Box 82132, St. Paul, MN 55182.

2. Each entry must be accompanied by an Atlantis proof-of-purchase seal, which can be found in the back of all Atlantis instruction books.

3. Each entry must also be accompanied by a photograph showing your peak score on Atlantis game #1 (other Atlantis games do not qualify). Note: The peak score is your final Atlantis total score and will be clearly designated as such on your TV screen at the completion of the game. Your name, address and telephone number must be clearly printed on the back of the photograph. All photographs must be readable and become the property of Imagic. None will be returned. Imagic is not responsible for lost, late or misdirected mail.

When photographing your screen **DO NOT USE A FLASH.** Hold camera steady for a 35mm, use a tripod or table. For an Instamatic 126 or 110, insert a dead flash to force lens open.

Any photograph that is duplicated, forged, mutilated, altered, illegible, tampered with, mechanically altered or irregular in any way is automatically void. We reserve the right to validate scores.

4. You may enter as often as you wish, but only one prize per contestant will be awarded and each entry must be mailed in a separate envelope and be accompanied by a photograph and proof-of-purchase seal, as described above. Proof-of-purchase seals and photographs may not be duplicated.

5. All entries must be received by October 24, 1982. Winners will be notified by October 31, 1982.

6. Prizes will be awarded as follows:

Four individuals with the highest peak scores will be invited to compete in the Great Defend Atlantis Shoot-Out on November 14, 1982 in Bermuda. The four winners must make the Bermuda trip on November 13-15, 1982 in order to qualify for the Grand Prize (\$10,000 in gold). If any finalist cannot make the Bermuda trip on the specified date, he will be awarded a \$1,000 runner-up prize. The fifth highest scorer will then be invited on the trip and be eligible for the grand prize but not for a runner-up prize. If there are tie scores in determining the contest winners, supplementary peak photographs will be required. Contestants with tie scores will be contacted by telephone and given the opportunity to submit a tie-breaking score.

No substitutes for trips or prizes will be offered, other than as stated above. Each finalist (plus one guest) will receive round trip economy class air transportation from home airport to Bermuda, double room accommodations (or the equivalent) for 3 days and 2 nights, ground transportation plus \$50 per day for meals, tips, etc. If any of the winners is a minor, his or her guest must be a parent or guardian.

On November 14, 1982 all four finalists will compete in a shoot-out for 1 hour. Peak scores during that time, as recorded by the judges, will receive the grand prize. In addition to the trip to Bermuda, prizes are as follows: Grand Prize: \$10,000 2nd Place: \$1,000 3rd Place: \$1,000 4th Place: \$1,000

Winners may use their cash awards towards the cost of a college education for themselves or a loved one. Winners, however, have the option of using their prizes in any manner they select.

### ADDITIONAL PRIZES:

Contestants who have submitted the next 250 highest scores will receive free snorkeling gear including snorkel, mask and fins. Contestants who have submitted the next highest 1000 scores will receive three Atlantis T-shirts.

Total prizes, including trips, cash awards, snorkeling gear and T-shirts are valued at \$40,000. All prizes will be awarded by December 31, 1982.

7. The contest is open to all residents of the United States. Employees of Imagic, their advertising and promotion agencies and Carlson Marketing and members of the employees' families are not eligible.

8. All participants in the Great Atlantis Shoot-Out will be required to execute an affidavit of release and eligibility and all guests of participants must execute an affidavit of release.

9. A list of winners will be furnished after December 31, 1982 to anyone who sends a self-addressed stamped envelope by November 13, 1982 to:

Defend Atlantis, P.O. Box 82125, St. Paul, MN 55182.

10. Contest is void wherever restricted or prohibited by law. No correspondence will be answered. By entering the contest, participants agree that all decisions by Carlson Company regarding entries and any aspect of the contest, are final.

11. Local, state, and federal taxes, if any, are the responsibility of the winners. All federal, state, and local regulations apply.



Created by experts for experts™  
981 University Ave., Los Gatos, CA 95030



# DEFEND ATLANTIS AND WIN ITS LOST TREASURE OF GOLD.

The fate of Atlantis is in your hands. Flying foes attack the submerged city on all sides. You command three missile installations. Track and destroy alien aircraft, or perish trying. If you're good enough, you'll compete for the lost treasure of Atlantis: a chest of \$10,000 in gold!

All you have to do is take a photo showing your score on the screen. Send it in with your entry form and the Atlantis proof-of-purchase seal from the instruction book. Only scores from the Atari® Home Video Computer System™ are eligible. You must play Atlantis game #1. See accompanying Official Contest Rules for details.

## FLY TO BERMUDA.

Be one of the four top scorers to fly free with a friend or parent to Bermuda and compete in the Atlantis playoffs for the treasure chest. The three runners-up will win \$1,000 each.



Atlantis Game for Atari® VCS

**OVER 1,200 PRIZES  
WORTH \$40,000.**

But even if you're not one of the top four, you can still win a complete snorkeling set for being one of the first 250 runners-up. Or a

"Defend Atlantis" T-shirt for being one of the next 1,000 runners-up.

Hurry. You must enter before October 24, 1982. Atlantis needs your help now!

**WIN \$10,000  
THERE'S \$40,000 IN PRIZES!**

Name \_\_\_\_\_ Age \_\_\_\_\_

Address \_\_\_\_\_

City \_\_\_\_\_ State \_\_\_\_\_ Zip \_\_\_\_\_

My score from Atlantis game #1 \_\_\_\_\_  
(Valid only with photo)

T-Shirt Size Child S M L Adult S M L

I am enclosing my photo and proof-of-purchase seal

Mail to: "Defend Atlantis," P.O. Box 82132, St. Paul, MN 55182



Created by experts for experts™



# Custom

## How to Add a Joystick and Other Frills to Your Mini-Arcade

By HENRY B. COHEN

If you own a Coleco **Pac-Man** or **Galaxian** stand-alone arcade machine, chances are good that you're as crazy about it as we EG editors are about ours. Still, wouldn't it be fun to play this mini-maze-chase with a full-size joystick? And let's face it, all those wacka-wacka's can get on anyone's nerves from time to time.

This article will show how, with a minimum of effort, you can modify your Coleco tabletop unit so that it can utilize an Atari-configured joystick. And while we're tinkering, we'll also be adding a volume control and an AC adaptor socket.

If you've never considered the idea of using a videogame controller on a stand-alone, mull it over. In our opinion, adding such a joystick is one of the greatest possible improvements anyone could ever make on a portable electronic game. With a real stick in your hand, the days of hunching over the unit or pinching your fingers around the built-in command device will be no more than a mildly painful memory.

These enhancements really heighten enjoyment, too! In a darkened room, the total effect is similar to playing a coin-op machine. The Coleco mini-arcades may be small, but there's nothing tiny about the quality of the actual games.

The total parts cost for this project should run no more than \$12.00 a game. Installation will take no more than two hours of your time.

Before heading into details about the Coleco units, a few facts are worth noting. The built-in joysticks are about as good as any to be found in hand-

held or table top units. It's just that they can tire your fingers after several heavy rounds of play. Metal fatigue is also a consideration. The Coleco joystick switches (and firing buttons) are simply sprung metal which is depressed by the base of the joystick (or

happen, due to their greater size and beefier parts. Micro switches would work better and last much longer, but their greater cost would raise the price of the game considerably.

The decision about whether to add an AC adaptor jack is up to you. Within

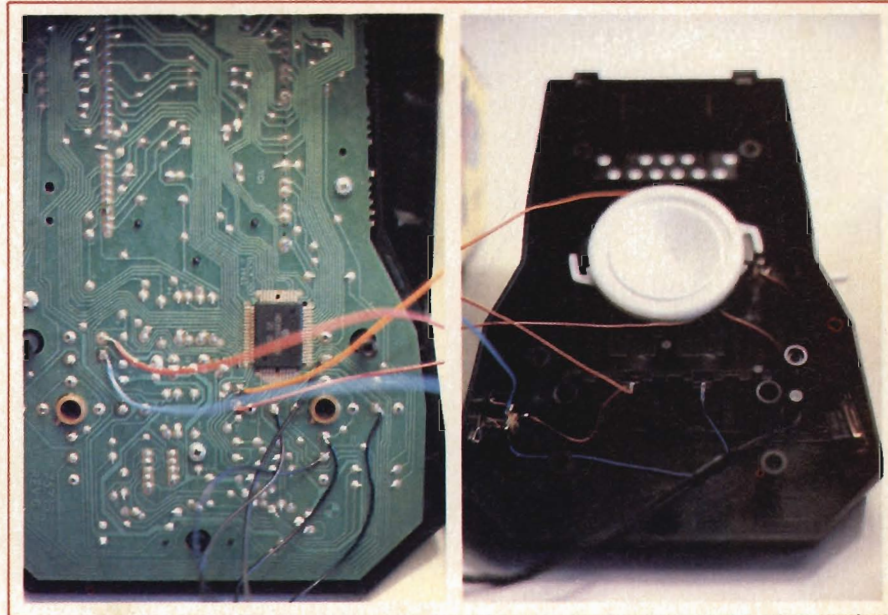

(On the left) Here we see the four black wires connected to the correct points on the circuit board for the left-hand joystick operation. (On the right) illustrated in this photo are the correct hook-up points for all three modifications.

firing button) as it is positioned during play. In essence, they use the "tin-can" effect of pushing down on rounded metal and letting the metal spring back. If you keep depressing metal over a long period of time, it begins to lose its springiness. This is why the joystick response of handheld games eventually begins to taper off. The same effect occurs with standard-sized joysticks, only it takes longer to

a few months, Coleco will be selling a unit called *Perma-Power* which works with its portable Arcade machines. If you already own an AC adaptor you might wish to add the jack to your Coleco games. If not, you may want to wait and purchase the factory device when it becomes available. The *Perma-Power* unit will work without any modifications whatsoever.

Before heading out to the store for



# izing COLECO'S PAC-MAN!

parts, read these warnings. One, any modification voids the manufacturers guarantee. Unless you're willing to risk an accident, do not alter these games until the end of the 90-day grace period. Even though these modifications can in no way harm the machine, Coleco may not service a unit that has been "tampered with". Two, you must possess rudimentary electronic skills, specifically soldering, before you perform the recommended surgery. While some connections may be crimped, wiring to the printed circuit board must be soldered. Either learn how to do it, or find a friend who can solder for you.

Whether or not you can solder, you can cut/drill or punch the needed cut-outs in the cabinet and mount the parts yourself. This requires mechanical aptitude, not electronic ability.

Before beginning work, assemble both the parts you'll need and the appropriate tools. A 30-watt soldering iron, solder, long nose and diagonal pliers, screwdrivers, knife, drill and bits should get you through. It's also a good idea to have regular Scotch tape and electricians tape on hand and a set of soldering aids.

Parts you'll need a 9-pin male connector, often referred to as a DBC 9P. If this designation draws blanks at the store, ask for an Atari joystick male socket. That should work. Along with the socket you'll have to buy nine "solder type" pins for the socket and mounting hardware for the volume control, you have a choice. EG has elected to use a

high-low volume switch. This is simply an SPST (single pole/single throw) on-off switch with a resistor wired across it. You may use this design or buy a standard rotary volume control. The latter is called a potentiometer. If you purchase the switch, Radio Shack's 275-324 or equivalent is recommended. If you opt for total volume control, any 30K-ohm potentiometer will do as long as it fits into the games cabinet. The coaxial adapter jacks used in this modification are Radio Shack number 274-1549.

You may, of course, use these same

jacks, or any others that fit your AC adapter. Just be sure to get the kind that are always on, so that when you remove the adapter plug, the batteries will take over. For resistance across the volume control switch, a 15K ohm will do, or you may experiment starting at about 10K ohms and working up to 20 or 25K ohms. The higher the resistance, the lower the volume.

Because the games operate on very low voltage, heavy gauges of wire are not needed. In fact, they may not fit

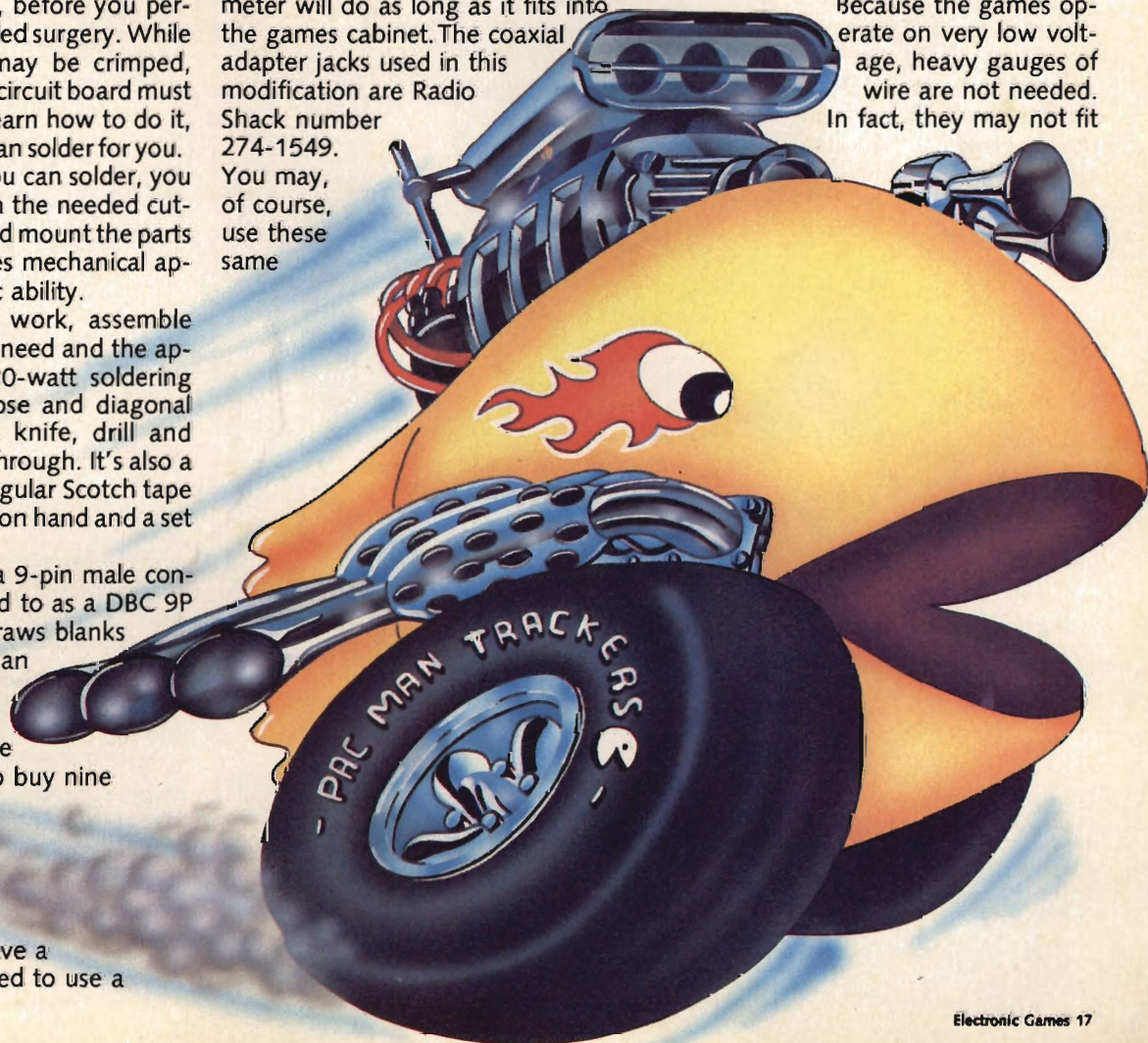



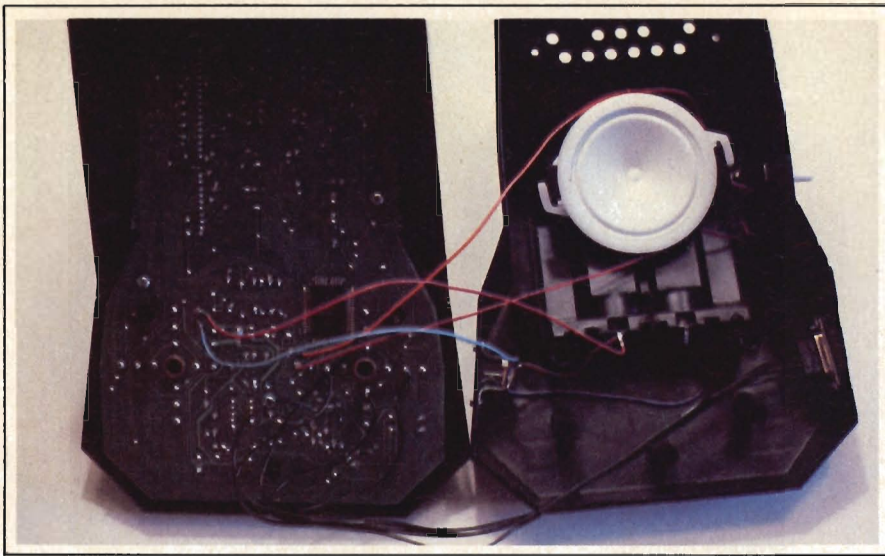

When all the work is completed, this is exactly what your personally customized Coleco tabletop Pac-Man should look like. If your handiwork matches this picture, then put it back together and start playing.



into the game cabinet and may put too much of a strain on the printed circuit board. For this reason light gauges are the order of the day, 24-28 gauge stranded will be fine. Try to get an assortment of colors as this will make circuit tracing easier should the unit ever need service. We advise you to get red, blue, black and yellow. The final installation will look far more professional if the wiring is color coded.

Once you have assembled the required parts and tools you are ready to begin. Keep in mind that these modifications are, at least electronically speaking, easy to make. Do not, however, rush them. If you do, you might damage the circuit board or mislocate a part so that it doesn't fit properly. Think things through as the work proceeds, and your modifications will proceed smoothly and look and perform as though installed by a professional.

Begin by removing the five philips head screws that hold the game together. They are all mounted at the bottom of the unit. Do not remove the screws that hold the cover of the machines to their faceplates, located under the game controller label.

Carefully finesse the game apart. Take your time, it will come. Place it on the table before you.

Decide where you would like to mount each jack and switch. We have positioned the joystick socket on the lower right, the AC adapter jack on the lower left and the volume control switch on the right hand side of the speaker device. This configuration works well, unless you are going to wire in two joystick sockets. In that case, the lower right and left will have to be used for this purpose and the AC jack put elsewhere. This example only shows the wiring of the primary controller and does not provide the pin locations you would need for the other socket. If you want both, we will tell you how to figure out the wiring plan.

Mounting the volume control switch and AC jack is a simple drilling job. To cut the hole for the joystick socket is a bit tricky. We've found that the easiest way is to first place masking tape on the area where the socket will be located. This trick allows you to trace the outline of the socket before you cut the plastic. Or you may simply trace the outline of the socket directly on the plastic with an Exacto knife. Be careful with this tool as it is razor sharp and you can't play any games without your fingers.



Once you've traced the outline, drill a series of small holes within the space you've drawn until the knife can be used for final trimming, or you can use the knife exclusively for cutting the hole. This latter method works but it is slow and tedious. Once the hole is cut through, a small nail file can do the final finishing. If you err and make the hole too large, you can always mount the socket from the outside in (the wrong way, but it works), rather than the preferred, inside out. At least you can disguise small miscalculations in this manner.

Once all the holes are cut and drilled, it's time to wire the parts. Don't mount them at this time as soldering is easier if the parts can be moved about as necessary.

We have illustrated the wiring on a **Pac-Man**, not a **Galaxian**. For the AC adapter jack and volume control, the wiring plan is the same for either unit. Only the joysticks are wired differently.

At the center of the right-hand (facing you) joystick, switch 2, there is a series of printed circuit wiring connections that attaches all innermost switch contacts to the other. This connection's called a "ground". Near switch 2, there are four numbered pin connections: 1,2,3 and 4. To any one of the ground points, and to each of the numbered pins, solder a 10-in. length of (preferably black) wire. To the other end of each of the five wires carefully solder one of the pins that fits the Atari joystick socket. If you turn on the game after completing this wiring stage, you may actuate the controls of the game, as though using the joystick, by touching any of the wires coming from a numbered switch pin to the wire connected to ground. This is the same as throwing one of the joystick's switches. It is also, and most importantly, the process by which you can determine which wire goes to which pin of an Atari controller. On all Atari joysticks, the ground wire is connected to pin number "8". By pushing the ground wire pin into pin 8 of the Atari joystick and experimenting with the other wires while the game is "on", you can see which wire is effected by which switch in the joystick and change wires (except ground to pin 8) until you get the proper response. Try a game this way to insure that all pin connections are working properly. Once you are certain of the pin connections (see illustrations), install the pins in their appropriate positions

in the nine-pin socket. Use a soldering aid or thin brad for this purpose. Force the pins into the sock with some effort, then mount the nine-pin socket, with wires attached, permanently to the game console. Every 2 in. or so wrap the five controller wires with black electrician's tape.

You have just built your first cable. Congratulations! For **Galaxian**, the joystick wiring procedure is just about the same as for **Pac-Man**, but the pin numbers are different, and there are fewer wires to trouble you. Now that you know how to wire and check controller cabling, you can use the same routine to install the right-hand joystick.

This method works for most handheld or tabletop games.

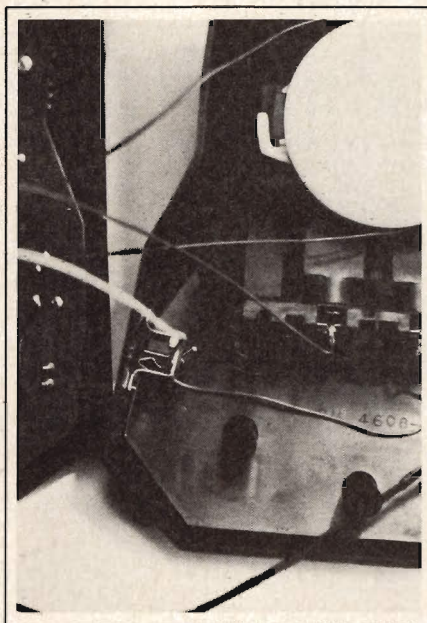

Here's a close-up of the correct assembly shown atop the previous page. Note where connectors meet.

Installing the volume control is even easier. Simply locate the two speaker wires and cut one of them about 3 in. from the speaker. Do not cut the other wire. Each end of the speaker wire should be stripped and soldered to the terminals of the volume control switch, and the resistor should be soldered across the two switch contacts (see illustration). In effect, when the switch is "off", the resistor completes the audio circuit by shorting out the switch while cutting down the voltage that reaches the speaker. This, of course cuts down on volume. When the switch is "on", it shorts out the resistor and restores full volume. If you omit the resistor entirely, the switch will act as an "on/off" device.

Those desiring full control of volume

can use a potentiometer (variable resistor) instead of the resistor/switch arrangement just described. In that case, simply solder one end of the cut speaker wire to either of the end terminals of the "pot". The other wire is soldered to the center connector.

To install the AC adapter jack, solder a short length of red wire to the terminal coming from the center pin of the jack. Connect the other end of this lead to the terminal of the battery-holder that is wired to the circuit board with a red wire.

The blue wire running from the battery-holder to the circuit board must be cut. Connect the end that comes from the battery pack to the terminal of the adapter jack that is sandwiched between the two plastic insulators. The blue wire from the circuit board is then connected to the remaining contact on the jack which should be touching the metal casing of the jack. When testing this circuit the AC adapter may work fine but the batteries don't power the unit. If that occurs, you may have to bend a little metal in the jack which is pushed aside by the AC adapter plug. It's a minor mechanical adjustment, not a major calamity. A quick look should reveal exactly where the source of the problem is. Slight pressure on the offending contact will set things straight immediately. It's almost harder to explain than to do.

Remember, that the factory wiring isn't going to be long enough to allow you to make all connections without additional wire. Think each step through before you cut, and use the factory wiring to your best advantage. Supplement it as needed with 24-28 gauge stranded wire. If a factory wire is to be replaced, carefully unsolder it from its source and discard it. Do not splice wires together; only use the proper and complete length for each wiring job. The results will look better, and there will be less possibility of wiring failure. Also, to make soldering to the circuit board a lot easier, use Scotch tape to hold down wires in their proper positions before applying heat.

Lastly, these kinds of modifications can be made to any handheld or tabletop game, assuming there's enough room to hold the parts. If you have a favorite, try to wire an external joystick socket or switch and let us know the results. See if you don't agree that an external joystick and volume control add a new dimension to these Col-eco games.





By THE GAME DOCTOR

Cherio, gamers, it's the jolly old Game Doctor here to answer your questions and solve your dilemmas about the sometimes confusing world of electronic gaming. Fall breezes are beginning to blow, but we would be quite comfortable in my climate-controlled office. Of course, you'd be much warmed if you won an official **Electronic Games** T-shirt for sending in the month's most interesting query.

Taking a giant step toward true sartorial splendor this month is Jimmy Trotter of Kenosha, Wis., who asked something that many Atari VCS owners may have always wondered about. So, take it away, Jimmy!

**Q:** As an Atari VCS owner, I am curious as to why the company has changed its console switch positions. On my system, there are four switches in front with the two difficulty selectors on the rear panel. My friends who own Atari units all have six switches on the front. Do I have an older model or a newer one?

Also, are there any internal differences in the two sets? If so, which is better?

(from Jimmy Trotter, Kenosha, WI)

**A:** Actually, Jimmy, you're the lucky owner of the latest in the Atari 2600 VCS series, though this medicine man has a preference for the older models. The reason for the change is simple engineering efficiency. It's much easier for the difficulty switches to be routed through the rear of the console, nearer the joystick/paddle inputs. Other than that, the interior is exactly the same.

The only problem with the new model, of course, is that you may forget having set a difficulty switch and, not being able to see it, may experience some heavy-duty hassles in

your game play before realizing that you've got the handicap on!

**Q:** We own an Atari VCS and it has recently begun playing by itself, even without the joysticks plugged in!

In **Bowling**, for example, you hit reset and the bowler throws the ball. Plugging in the joysticks allows you to curve the ball.

(from Joe Benedict, Aurora, IL)

**A:** Inside your VCS are numerous devices which connect with the pins found at the end of your controller

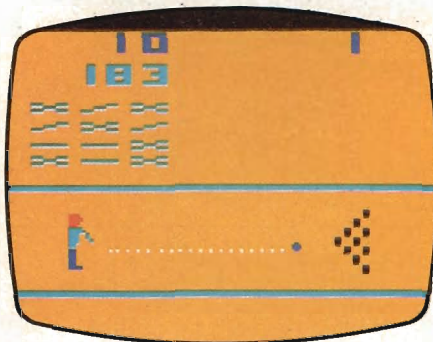

**BOWLING**

plugs, allowing signals transmitted by, say, the action button, to be (heh, heh) "triggered".

It appears that your system is locked into a position where the microprocessor thinks the action button is constantly being depressed.

Looks like the VCS is ready for a trip back to the shop for some I/O repairs. Of course, you *could* always just keep on playing "automatic bowling". No, I didn't think so. . .

**Q:** While I was playing Intellivision's **Space Battle** something very unusual happened. After I had attacked and successfully destroyed an alien squadron, a portion of that defeated

squadron stayed on the radar screen. After I re-engaged with the destroyed fleet, there were no ships to fight. This "empty" squadron ended up destroying my Mothership! What happened?

(from Brian Alexander, L.A., CA)

**A:** Unless this is a chronic problem, the Doctor's guess would be that the game program didn't load properly into the computer. In other words, even though those enemy ships had been blown up, the information was not being relayed to the microprocessor due to the incompleteness of the program. So your Intellivision still registered those ships in its memory bank and sent 'em on ahead to wipe out your poor, dear mama craft.

Programs on ROM cartridges, however, load incompletely so infrequently that incidents such as this are moderately rare,—though indisputably frustrating.

**Q:** Any plans for VCS versions of **Tempest** and **Star Raiders**? Also, can the **Supergame (5200)** controllers be adapted to the VCS (2600)?

(from Eugene Chong, Ont., Canada)

**A:** Long ago the Doctor learned never to say never when it comes to VCS designers adapting sophisticated coin-op hits into home format, but a VCS version of **Tempest** would be an incredible design challenge. But how about some good news? A VCS version of the Atari 400/800 computer smash, **Star Raiders**, will be in the stores this year! The game not only employs joysticks, but uses the keypad controllers with Intellivision-style overlays that will allow gamers to enter the many sophisticated commands involved in this classic SF strategy and



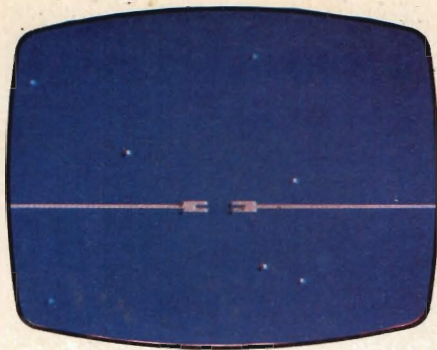

VCS STAR RAIDERS

tactics contest. It's both a great idea, and a marvelous boost for the heretofore under-utilized keypads.

The controllers will not interface with the VCS. The 5200, by the way, also has its own trac-ball type controller for use with games such as *Missile Command* and *Centipede*.

**Q:** When Atari's new Supergame comes out will the existing VCS cartridges be playable on it or will you have to buy totally new games for it? Please answer this question, as it is very important to several friends (as well as myself) who are considering buying the new system when it comes out.

(from Jeffrey Acker, Palmerton, PA)

**A:** Hmm, must be an echo in here. Or maybe it's that "deja vu" stuff. To answer your question, Jeffrey, you will

not be able to play VCS games on the new system—which, at last report, is being referred to as the Atari 5200—or use the souped-up 5200 games on the VCS.

There is, however, a totally unconfirmed rumbling regarding a VCS "emulator" such as the peripheral attachment ColecoVision is promising for its game system. Once this is plugged into the 5200, VCS cartridges would plug into it, in turn, allowing the 5200 to run the games Atarians already own. Again, this is still firmly in the realm of pie-in-the-sky speculation.

INTELLIVOICE



VCS WITH SPORTS GAME CARTRIDGES



MISSILE COMMAND (5200)

**Q:** After reading in EG about the new Intellivoice unit for the Intellivision, I was wondering whether the game cartridges for the regular and voice units can be interchanged. I realize the regular games won't talk, but will it damage the cartridge in any way?

(from Terry Barr, Bloomfield Hills, MI)

**A:** Compatibility, compatibility—my joystick for some compatibility! No, Terry, those games you've been playing on your master component won't work with the voice module, though

this is a moot point since the Intellivoice plugs and un-plugs with the same ease as an ordinary cartridge. New, special (and non-compatible) cartridges must be purchased for voice-capability.





**Apologia:** A recent installment of "Insert Coin Here" made mention of the fact that a new game by Pacific Novelty, *Thief*, attained its marvelous voice-over through the use of an innovative new phonetic voice chip from Texas Instruments. This information was conveyed to the author by yours truly, and a number of professional designers who shall remain nameless (but not unpunished!)

Though such a chip does exist, and will soon be featured in coin-op and perhaps even home videogames, it was *not* employed in *Thief*. This coin-op utilizes a tape loop voice-over to simulate the sound of a police dispatcher leading his men in pursuit of the felonious protagonist.

In any case, everyone from Pacific Novelty to coin-op repairmen have called us on the carpet for this one. Ho, boy. Sorry.

And while we're covering blunders, the munchers *do not* slow down when passing through the escape tunnels in *K.C. Munchkin*, scolds Chris Glasser, and he's right, too. Also, *Trickshot* is not the billiard game with the most cue positions (16). *Odyssey's Pocket Billiards* has 24 positions, but no english.

I'm telling ya, there's nothing keeps

us on our toes here at *EG* like our eagle-eyed readers. If we miss anything, there's bound to be someone out there—programmer or hobbyist or both—more than happy to point it out in loving detail. And that's the way we like it. Keeps us on our toes. Way to go, Chris.

As the Game Doctor goes into the study to shine up my monitor for some

video golf, I'd like to turn the remainder of the column over to *EG's* Technical Director, Henry B. Cohen. Since Henry's "Test Lab" report on repairing the VCS appeared in our March issue, he's gotten numerous requests for further information. In response to this, he'd like to explain a few things to those folks who wrote in. So take it away, Henry. . .

## VCS DISTRESS ARTICLE: An After-thought

By HENRY B. COHEN

In response to the many *EG* readers who wrote concerning various aspects of the Atari VCS repair article I would like to address the following:

Whether or not such simple repairs exist for other game systems is not known by *EG*—yet. Only the service technicians can answer that question, and if any are readers, they are invited to contact the magazine and reveal their secrets.

Lastly, short of joining the repair departments of these companies, I know of no schools that teach home videogame repair techniques. Each

system is vastly different from the others and is parts-specific. You just can't get replacement parts for most game systems anywhere, like you can for many of the commercial arcade machines. As *EG* discovers other quick-fix plans, we will print these techniques. Simple procedures using common parts are the watch-words.

And again, the VCS repair described in the article applies to the early models of the 2600. It was said to be the most common failing of these units, except for controller malfunctions. Ⓞ

# Supercharge your Atari!

Just plug the BC-BLASTER™ into your ATARI in place of the joystick. Suddenly you get:

- Higher Scores
- Super Rapid-Fire
- No Cramped Hands
- Responsive Button Control

The BC Blaster is: Five feather-touch push buttons, housed in a 8½" × 5" control panel. Use the BC Blaster for any game instead of the joystick and experience fast, arcade-like action with the controller that makes your home game work like an arcade!



Pat. Pend.

Rush me the BC-Blaster! I enclose \$29.95 plus \$2 postage and handling for each unit. (Massachusetts residents add 5% sales tax.)

**Mail to:**  
BC-Systems  
59 W. Wyoming Ave.  
Melrose, MA 02176  
(617) 665-1588

Name \_\_\_\_\_  
Address \_\_\_\_\_  
City \_\_\_\_\_ State \_\_\_\_\_ Zip \_\_\_\_\_  
M/C number \_\_\_\_\_ Visa number \_\_\_\_\_  
Exp. date \_\_\_\_\_



# Phaser Patrol



## ENTER THE NEXT DIMENSION

**Turn your Atari® Video Computer System™† into a supercharged video game machine.**

Slip the Arcadia™ Supercharger™ into the cartridge slot of your Atari® set and enter the next dimension in video game excitement. The Supercharger™ gives your Atari® set the game-playing power of sets costing hundreds of dollars more.

And Supercharger™ game programs cost 40% to 60% less than conventional game cartridges.

Start with Phaser Patrol™, the extraordinary galactic odyssey that comes with the Supercharger.™ Plot your strategy on a full

screen sector map. Then fight it out with a challenging enemy on an incredibly detailed battle action screen. Take control of switchable shields, target-locking torpedoes, fully operational instruments, and starbase resources.

Included with Phaser Patrol™ are live action previews of other Arcadia™ games: Communist Mutants from Space.™ Fireball.™ and Suicide Mission.™ They're all a dimension ahead of anything you've ever played on your Atari® set.

† Atari® Asteroids™ and Video Computer System™ are trademarks of ATARI, INC. ARCADIA CORP. is not related to ATARI, INC.

© ARCADIA CORP., 1982.

**ARCADIA™**

**ARCADE ACTION COMES HOME®**

**"Phaser Patrol™ is the best home video game I've ever played on any set."**

Andy Breyer  
Champion  
1981 International Atari®  
Asteroids™ Tournament

*"The graphics on Phaser Patrol™ are as good as on many arcade games. And the game itself is*

*designed to stay challenging. Even to me."*





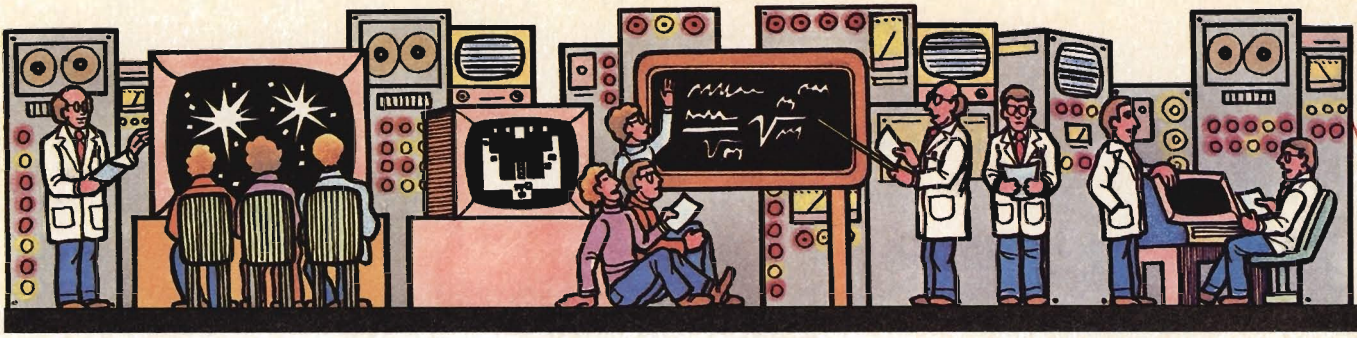

## Coring the Apple II

The Apple II is one of the most versatile micro computer systems ever developed. The Apple is a 6502-based machine with either Applesoft or Integer Basic built-in and, therefore, always available. Integer Basic is only available in the older versions of the Apple whereas Applesoft is found in the newer edition.

The most significant thing about the Apple is the tremendous amount of software available. Almost any arcade game has been, or shortly will be, written for the Apple. And there's an excellent supply of business and home orientated software.

The Apple is also very easy to modify to fit your own personal needs via the eight peripheral ports located in the interior of the unit. The first port, know as port #0, is used exclusively for a RAM or ROM card to expand memory capabilities beyond 48K. Ports 1-7 are used for disk interfaces, printer interfaces, speech cards, temperature

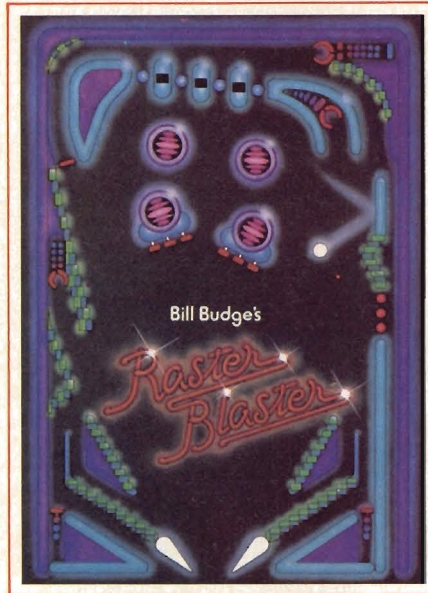

**RASTER BLASTER**

probes, modem cards, hard disk interfacing, Z-80 cards, 8088 cards and anything else you could possibly imagine. The game I/O port can support up to two joysticks or four paddles for game playing.

The two basics, Integer and Applesoft, are not compatible with each other so programs written in one BASIC will not work in a machine equipped with the other type of BASIC. The way around this drawback is either to get a ROM card that has the other basic on it or get a RAM card and load the other basic into this card via disk or tape. The two methods require the purchase of special cards which is a pain in the pocketbook. The RAM card itself is very versatile, because you can load PASCAL or your program into its memory, giving the Apple 64K instead of 48K.

The keyboard closely resembles a standard typewriter keyboard with the addition of several keys. A bad thing about the keyboard is the fact that the reset key is just above the return key.

This greatly increases the chance of making a tragic error. The keys are adequate for game playing, but it is still better to use a joystick or paddle for action games.

The Apple has two low-resolution graphics screens and two high-res graphics screens. The low-res picture screens are best suited for simple drawings and pictures with varied colors. The high-res picture screen is perfect for depicting game battlefields and detailed illustrations, but there are only six basic colors in hi-res instead of 16 for low-res. So the choice is simple: If you want color use low-res, if you want detail use high-res. (Some games, (like the Hi-res **Adventures** by On-Line Systems), can give you both detail and color on the hi-res screen.

When in the text mode, the system's display can show 24 lines of 40 characters each in black and white. The Apple can also support lower-case letters with a lower-case adapter.

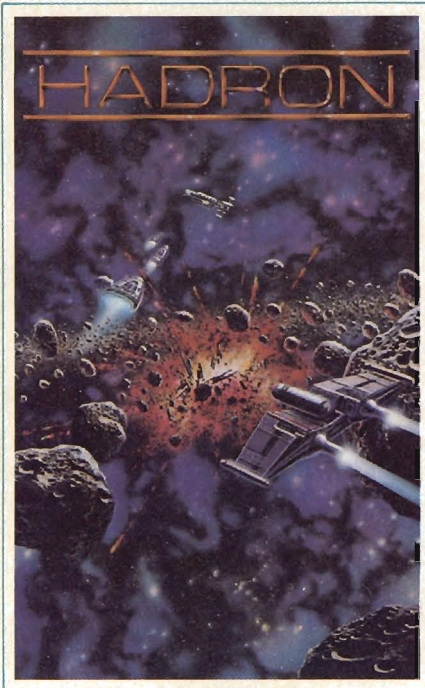

**HADRON**



**GORGON**



# TEST LAB

Sorry, no color for the text screen.

The feature that raises this computer above others is the built-in assembler and dis-assembler. This program allows the user to directly access memory for BASIC with one command. It makes machine language programming much easier and simpler than ever before. The dis-assembler is used to read what is in the memory, whereas the assembler is used to write a machine language program by typing the special commands the 6502 can understand. A trace function in the dis-assembler permits computerists to follow your program and see what it does; in other words you could find out where and how your program bombs.

Most of the software for the Apple is stored on disk. If you don't have a disk drive, you're at the mercy of those suppliers who also put their programs on cassette tape. The Apple is essentially disk-oriented, because many, if not all programs are of substantial memory size and would take forever to load on cassette. There is even a small-scale war going on between companies making software on disks that you can't duplicate and software pirates who are finding ways to copy the uncopyable. (Eventually, it seems the pirates get their way, because few programs remain uncopied for long.)

The cassette I/O is located in the rear of the unit, and the port broadcasts at 300 baud. Three-hundred baud is a very slow speed in comparison to other systems that have cassette I/O.

Any Apple II is the perfect hunting ground for hardware "hackers". Every component is clearly marked and labeled

on the main printed circuit board. Complete schematics are found in the manual that comes with the



# SNAKE BYTE



VIDEO GAME JOYSTICK™  
**SKIL-STIK**

INTELLIVISION OWNERS

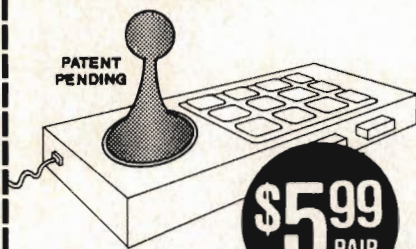

- IMPROVE SKILL
- GREATER ACCURACY
- LESS FATIGUE
- MORE CONTROL
- HIGHER SCORING
- SIMPLE TO ATTACH

DISTRIBUTOR COST INFORMATION  
 WRITE OR CALL 401 331-3200

Send \$5.99 plus 50¢ shipping to:

**: C & T CREATIONS :**

127 Weybosset St., Providence, RI 02903

(PLEASE PRINT)

NAME \_\_\_\_\_  
 ADDRESS \_\_\_\_\_  
 CITY \_\_\_\_\_ STATE \_\_\_\_\_ ZIP \_\_\_\_\_  
 Send check or money order — Sorry no C.O.D.'s.

# The MENU

for the Video Gourmet!

## YOUR #1 GAME SOURCE

Respected brands such as Atari, Intellivision, Activision, Imagic, Odyssey, Coleco, Parker Bros., Apollo & more at our everyday

**low prices.**

Unique Items for the  
 Game Gourmet  
 &

Our Exclusive Newsletter  
 (ask for free sample)

The MENU is free and packed with goodies!  
 Get your copy now and start saving \$\$

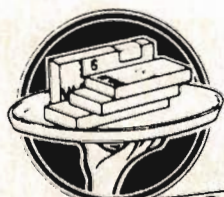

**VIDEO TAKE-OUT**

12115 Magnolia, # 126  
 P.O. Box 4702  
 No. Hollywood, CA 91607  
 (213) 761-1561

26 Electronic Games

# TEST LAB

## APPLE II AT A GLANCE

Price: \$1430.00 (32K), \$1530.00 (48K)

CPU: 6502 Microprocessor

Colors: 16-color low-resolution graphics, 6-color hi-res graphics

Sound: Single tone generator with speaker inside computer

Languages: Pascal, BASIC, Cobol, Assembler, Forth, FORTRAN, Pilot  
 (note that some languages require the language card \$495)

ROM: 12K

RAM: 48K

Special Features: Built-in Assembler and Dis-assembler for Assembly language programming.

Monitor: Uses standard video monitor or can be used with a home TV with purchase of an RF modulator (\$40).

Games: These include **Ultima, Taxman (Pac-Man), Gorgon, Horizon V, Night Crawler, Sneakers, Bug Attack** and **Time Zone** (a 6 disk long adventure).

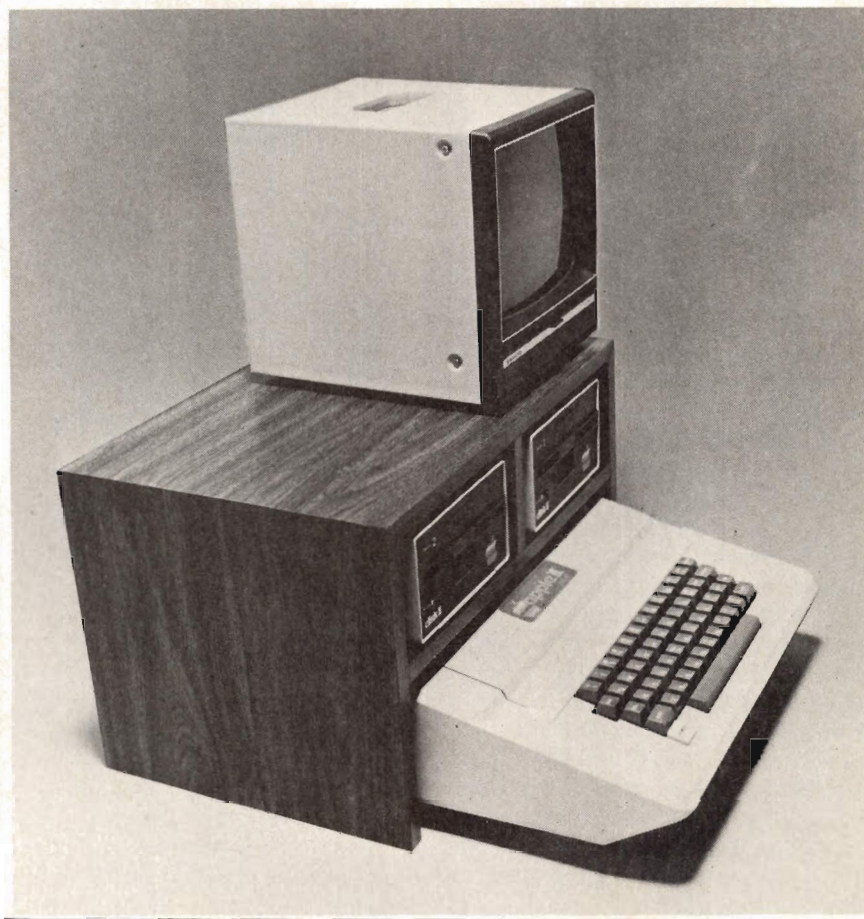

Apple II computer, so minor trouble-shooting isn't much of a problem.

The switching power supply is in a metal case just left of the main board. The metal box is there to shield against interference from the power unit. It's not recommended to do any kind of work on any circuit board without first pulling the plug.

It is good to know that the Apple

Computer Company is continually making new software and hardware for the Apple II (and its new system the Apple III). Overall, the Apple II is probably the best personal computer on the market today. Massive software and hardware research and development means that the Apple II will not become forgotten for some years to come.





# COMPUTER GLOSSARY

**Auxiliary Storage:** Devices used for saving programs when the system itself is turned off. Since RAM loses its contents when the machine is powered down and ROM can only be programmed by the factory, auxiliary storage keeps programs between operating sessions. It can't be used instead of RAM or ROM, however, since it doesn't operate as fast as the CPU.

**CPU:** Central Processing Unit. This is the microprocessor—or electronic brain, if you will—that lies at the heart of every computer.

**Disk Drive:** An auxiliary storage device that works like a cross between a phonograph and a tape recorder. By using plastic disks coated with a magnetic surface, such drives are faster and more reliable than cassette storage.

**Interface:** The part of the computer that permits the attachment of peripheral devices. These include cassette recorders, joysticks and a connection for a TV set or monitor.

**Modem:** Modulator-Demodulator. It is a piece of equipment that allows computers to communicate with each other over telephone lines.

**Interpreter:** This translates programs from human-readable form into a series of codes the computer can understand. This makes using a computer a lot simpler for first-time programmers.

**RAM:** Random Access Memory. This is the internal memory the computer actually uses when running a program. It can be revised or read an infinite number of times.

**ROM:** Read Only Memory. This type of memory is also internal to the system, but it cannot be altered by the computer operator. Its contents are fixed at the factory and can't be changed. Most computer games bought in ready-to-play form fall into this category.

YOUR CHOICE OF ANY CURRENTLY AVAILABLE

## VIDEO GAME CARTRIDGE FREE

RECEIVE ABSOLUTELY FREE ANY CURRENTLY AVAILABLE VIDEO GAME CARTRIDGE\* FROM:

ATARI-VCS, ACTIVISION, BALLY, APOLLO, COLECO, U.S. GAMES, PARKER BROTHERS, IMAGIC, INTELLIVISION, ODYSSEY, BREAKTHROUGH, & SPECTRA VISION.

### MEMBERSHIP INCLUDES:

Our video exchange club, special discount coupons, membership contests, newsletters with new video information and tips. Plus many free offers.

### \*With the following exceptions:

Odyssey Challenger Series Games, Odyssey 2, Quest for the Rings, Conquest of the World, Stock Market Challenge, Intellivision Chess, Intellivision Air / Sea Battle, Dungeons and Dragons, Space Hawk, Utopia, Star Strike, Night Stalker, Minotaur, Land Battle, Bally Basic, Bally Music Maker, Creative Crayon, & Coleco Vision Series.

When you join our video exchange club. (Just send \$35.00 today in a check or money order, and your choice of ANY\* Video Game Cartridge.)

### FOR INFORMATION

Send a \$2.00 check or money order which will be credited towards your first exchange or purchase. We also have all the latest cartridges in stock at discount prices.

Limited time offer  
Allow 4 - 6 weeks  
for delivery

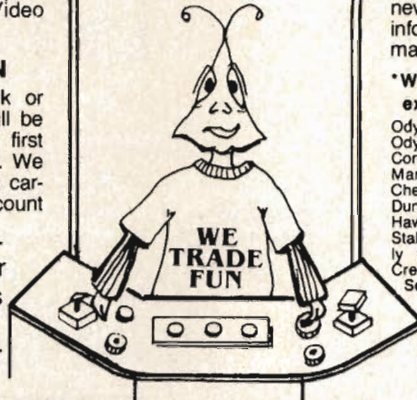

**VIDEO FUN & GAMES INC.**  
Box 1010 1204 Ave U, Brooklyn, N.Y. 11229

# "THE GAMEKEEPER"

ORDER YOUR CUSTOM DESIGNED PORTABLE VIDEO GAME TRAY AND YOU'LL BE PLAYING WITH THE PROS. CRYSTAL CLEAR ACRYLIC TRAY NEATLY ORGANIZES AND PROTECTS YOUR GAME CONSOLE, PLAYER CONTROLS, AND 12 GAME CARTRIDGES.

**\$24.95**  
PLUS \$3 FOR POSTAGE AND HANDLING



Please rush "GAMEKEEPERS" for my Atari™  Intellivision™  Odyssey™  To:

NAME \_\_\_\_\_

ADDRESS \_\_\_\_\_

CITY \_\_\_\_\_ STATE \_\_\_\_\_ ZIP \_\_\_\_\_

Check or money order enclosed  VISA  MasterCard

Acct. # \_\_\_\_\_ Exp. date \_\_\_\_\_

Send order to: ADI ELECTRONICS, DEPT 2, RT 100, SO LONDONDERRY, VERMONT 05155.

In a Hurry? CALL TOLL FREE 800-451-4453 EXT. 9. IN VERMONT, 800-622-4429 EXT. 9.

VERMONT RESIDENTS ADD 4% SALES TAX.



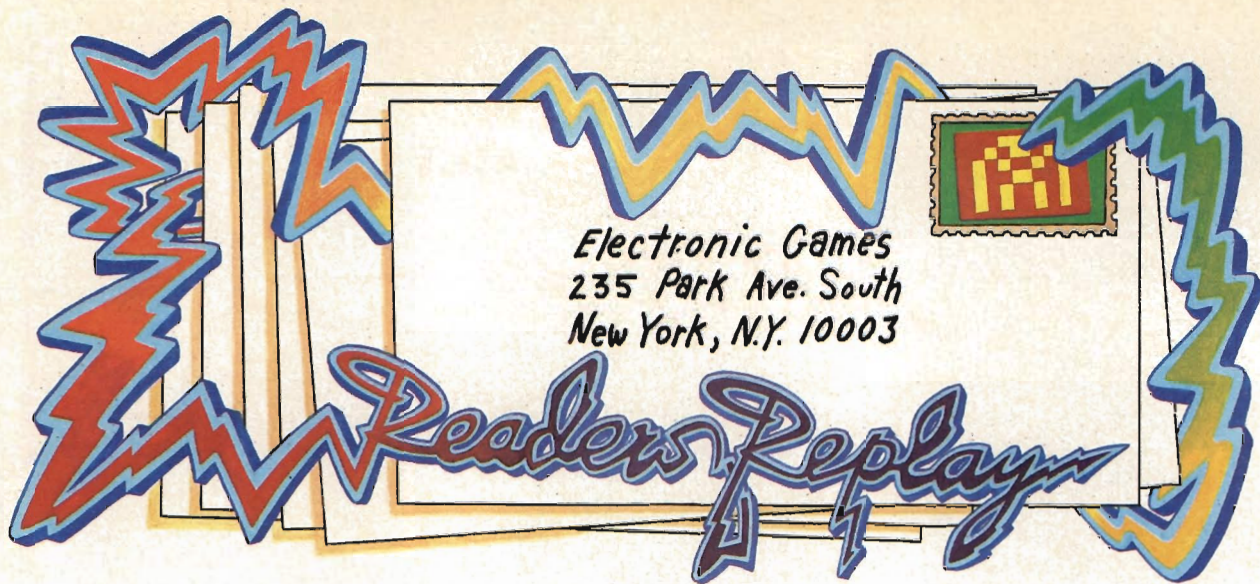

*Electronic Games*  
 235 Park Ave. South  
 New York, N.Y. 10003

# Readers Replay

## SERIOUSLY, FOLKS

In "Readers Replay" in the June issue of **Electronic Games**, you stated that the new Atari adventure entitled **Raiders of the Lost Ark** had previously been dubbed **Foxbat**.

In actuality, **Foxbat** had absolutely nothing to do with **Raiders**. This is an original cartridge written by the same programmer/designer—or "software chef" as he would say—who conceived and programmed **Yars' Revenge**.

Karen Johnson  
 Atari, Inc.  
 Sunnyvale, CA

*Ed: The comment to which you refer was in the nature of a jest, referring to the way announced schedules and actual production sometimes diverge. Foxbat, obviously, is a modern-era air combat game that is far, far from the setting of Raiders of the Lost Ark.*

## TAKE THE SHIRT OFF OUR BACK

In your second issue, you asked, in the Reader Poll, if readers would like an **Electronic Gaming** club. Has there been any further word on this?

Also, are **EG** T-shirts going to be made for readers?

Ernest Sevenser  
 East Detroit, MI

*Ed: Response to the idea of a club was very positive, but we are wary of rushing such a project. When Electronic Games sponsors a club, you can guess that it won't just be a device for separating gamers from their hard earned money. When we're ready with something good, you'll see an announcement. And speaking of announcements, look elsewhere in this issue for information on ordering T-shirts.*

## HUNTING FOR EASTER EGGS

I recently purchased **Yars' Revenge** and, true to Atari's claim, there is a secret message in it. Six letters—**HSWWSH**—appear on the scoring screen when it's found. These are the game designer's initials printed normally and then backwards. Also, the

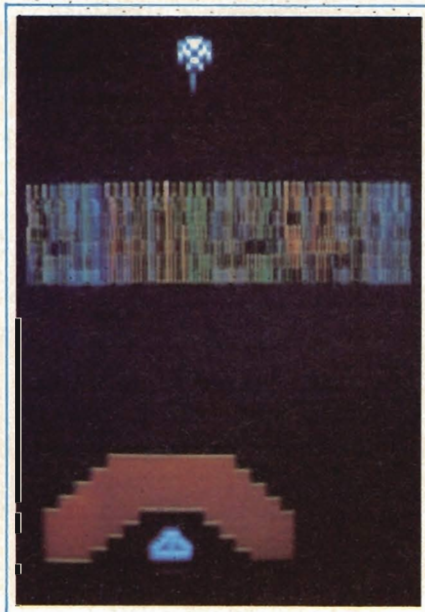

**YARS' REVENGE**

game seems to stop once the message is discovered.

I'd also like to say that your magazine is the best in the field of electronic games.

Please give more information about the new ColecoVision. It seems to be a great machine, especially with that Atari adapter.

Jim Lazar  
 Port Washington, MI

*Ed: Look for a complete analysis of ColecoVision in the December Electronic Games.*

## SELLING YOUR PROGRAM

I have programmed a game on my VIC-20 computer. What can I do with it?

I also have an idea that would make the Intellivision controllers better, like putting a joystick on the disk.

John Fitzpatrick  
 Summit, NJ

*Ed: While most companies are reluctant to get involved with gamers who merely have an idea for a program, those who go the next step and actually produce a finished, playable game generally get a warmer reaction. If you've got a VIC-20 game with commercial potential, your next move should be to approach either Commodore or one of the independent companies making software for this computer system.*

*Incidentally, you're not the only one with ideas about improving the Intellivision controllers. Several designs have already crossed this desk, and at least two companies intend to manufacture such enhancements.*

## COMPATIBILITY REVISITED

I just bought your magazine today, and I think it's great! I am an Intellivisionist, and I read in "Readers Replay" that Imagic is going to make the first Intellivision-compatible cartridge. What does that mean?

Tod DiPasquale  
 (No address given)

*Ed: Here's the lowdown on compatibility. Each of the videogame systems — Atari VCS, Mattel Intellivision, Odyssey, Odyssey 2, Astrocade, and so on — can only use the cart expressly designed for it. That is, you can't jam a VCS-compatible cartridge*



# Gamers Hit Parade... one Call Gets It All!

## INTELLIVOICE™



Space Spartans  
Bomb Squad • B-17 Bomber  
TRON Solar Sailor



Astroblast • Space Attack  
Lock 'N Chase • Frogs & Flies  
Super Challenge Football  
Super Challenge Baseball  
Armor Ambush  
TRON Deadly Discs  
Dark Cavern • High Seas  
International Soccer

## INTELLIVISION®

What's New?  
Utopia  
New Dungeons & Dragons  
Lock 'N Chase • Frog Bog  
TRON Maze-A-Tron

## ACTIVISION BEATS THE REAL THING.

Star Master  
Chopper Command  
Pitfall  
Megamania  
Pitfall • Stampede

## IMAGIC

Cosmic Ark  
Atlantis  
Star Voyager  
Demon Attack  
Swords & Serpents  
Fire Fighter  
Riddle of the Sphinx  
Atlantis  
Demon Attack



Lost Luggage  
Space Cavern  
Space Chase  
Shark Attack

## COLECO

Donkey Kong  
Donkey Kong

## PARKER BROTHERS

Frogger



Star Wars  
The Empire  
Strikes  
Back

## vidtec

Space Jockey  
Word Zapper  
Commando Raid  
Towering Inferno

## SPECTRAVISION™

Planet Patrol  
Gangster Alley



ATARI CX-2600



INTELLIVISION

**UNITED VIDEO OF AMERICA**  
P.O. Box 7333, Newport Beach, CA. 92660  
**1-(800)245-1111**  
In Calif: 1-(714) 955-2252



# ATARI 400 HOME COMPUTER



**\$249**

**16K**

32K...\$389, 48K...\$489

ATARI 410 Cassette \$76

ATARI 810 Disk Drive \$449

## ATARI 800 HOME COMPUTER

16K...\$649, 32K...\$729, 48K...\$769

COMPLETE SELECTION OF SOFTWARE

## computer mail order

east 800-233-8950

In Pa. Call (717) 327-9575

477 E. Third St., Williamsport, PA 17701

west 800-648-3311

In Nev. Call (702) 588-5654

P.O. Box 6689, Stateline, NV 89449

## !!VIDEO PRICE WAR!! COMPARE and SAVE

ATARI, MATTEL, COLECO,  
PARKER BROS. GAME CONSOLES

\*\*\*\*\*

### CARTRIDGES BY:

ATARI, MATTEL, U.S. GAMES,  
ACTIVISION, COLECO, APOLLO,  
and IMAGIC

(ALL THE NEWEST TITLES AVAILABLE!)

\*\*\*\*\*

### COLECOVISION:

MOST SOPHISTICATED HOME VIDEO GAME EVER!

- DONKY KONG, TURBO, VENTURE & MORE
- 8-WAY JOYSTICK WITH KEYBOARD & ROLLER CONTROLLER
- CONVERSION MODULE ALLOWS YOU TO PLAY CARTRIDGES AVAILABLE FOR ATARI

\*\*\*\*\*

## NEVER PAY HIGH PRICES AGAIN FOR VIDEO GAMES & ACCESSORIES

SEND SELF-ADDRESSED, STAMPED ENVELOPE  
FOR COMPLETE PRICE LIST.  
DEALER INQUIRIES INVITED. (516) 374-4704.

**NIK-NAT, LTD.**

4 ELDERD LANE

CEDARHURST, N.Y. 11516

into the slot of an Intellivision and expect anything much to happen. Independent software companies (meaning, in general, those which do not have a hardware gaming system) will usually choose one or two systems for which to make games. Imagic started with a trio of games usable on the Atari, but the company plans to make games for the Intellivision and Odyssey<sup>2</sup> as well. When Imagic's **Demon Attack** reaches the stores, it will most likely have the honor of being the first game cartridge for the Intellivision not produced by Mattel itself — that is, unless Coleco or Activision get their Intellivision-compatible games in the stores first.

### NEEDED: IN-STORE DEMOS

I have enjoyed EG for several issues now, and I feel a few comments are in order.

The "Test Lab" column in your July '82 issue was invaluable in hooking up my Atari VCS to my cable-ready television. The television was about one week old when your issue arrived, and up to that point, local video retailers had been no help in finding an in-line cable hook-up. The cable A/B switch with RCA-to-F adaptor was just what I needed (and thanks for the Radio Shack part number). The timing of this issue and my new set was uncanny.

With all the new cartridges becoming available for the various home videogame systems, one common problem shared by most of your readers is that very few retail outlets are willing to demonstrate all of the new titles. The more you can reproduce screen graphics and describe game action, the better. Thanks for reading my comments, and keep up the good work.

William Kates  
Ambler, PA

*Ed: Unfortunately, many large discount and department stores don't have the physical set-up — or, in some cases, the trained personnel — to provide extensive in-store demonstrations of new games. EG tries to fill the knowledge gap by presenting carefully considered reviews of new games as well as screen visuals. Sometimes, in the past, it hasn't been possible to get as many playfields as you — and we — would like. In response to the readers' overwhelming desire for more playfields, we've made some arrangements that are now putting more screens onto the pages of this magazine than ever before.*

### MORE REVIEWS WANTED

I love your magazine and have purchased every issue. However, there is one correction I might suggest. I own an Atari VCS and thus enjoy your "Programmable Parade" department. This treasured section has been reduced, not in quality but in quantity. In the first issue, there were 12 cartridges described, but in the fifth issue only five were discussed.

Please, don't cut down this section any more! It adds so much to your great magazine.

Jim Caram  
Erie, PA

*Ed: It's true that we did trim Programmable Parade" a bit after the first issue, but the coming flood of new VCS titles is causing us to add extra pages and expand coverage. Rest assured, EG will review as many videogames as the manufacturers publish.*

### ON THE RIGHT TRAC

The June issue was the first I have purchased. It really blew me away to see all of the forthcoming games for my Atari VCS. Of course, I may have to give up eating to pay for them all, and sleeping to have time to play them all.

I would like to see someone design a roller ball controller to plug into the Atari. I am very impressed by the one used in the **Centipede** game. A local pharmacy operates a cartridge rental service, which gives me the opportunity to evaluate cartridges that interest me without buying them. I realize that this is probably not a widespread practice in other areas, but it should be. They charge \$3.50 per week, plus 50¢ extra for each day over a week.

Ronald Holder  
Bridgman, MI

*Ed: You're not the only one who'd like one of those neat trac-ball controllers for home systems, Ron. Several companies will be bringing out VCS-compatible versions of this type of command device within the next couple of months.*

And that wraps up the letters for this issue of **Electronic Games**. We'd also like to thank the many readers whose excellent letters just couldn't be squeezed into the available space. Remember, if you've got a comment about one of our articles or features, or if it's just something about gaming you want to get off your chest, this is the column for your thoughts and opinions.

Ⓞ



# Wanna Be A Videogame Insider? Subscribe To **ARCADe EXpRESS**

## Read the hottest news of your favorite hobby in **Electronic Games Magazine's Sensational Bi-weekly Newsletter!**

If you're a true fan of electronic gaming, you're sure to love **Arcade Express**, the bi-weekly newsletter from the same folks who bring you *Electronic Games Magazine*. It's the "must read" publication for gamers who want the inside information about the world's fastest-growing hobby.

**Arcade Express** zooms into your mailbox every two weeks, packed with hot-off-the-press news about every facet of electronic gaming—programmable videogames, stand-alone devices, computer games and coin-ops. Plus, **Arcade Express** presents the inside, behind-the-scenes news of the major corporations that make up the videogame industry. Best of all, **Arcade Express** gets

you the big stories while they're still hot!

Each eight-page issue also features dozens of no-nonsense reviews of all the latest games. First, fast and factual—just what you'd expect from *Electronic Games*. But with **Arcade Express**, you'll know what's really happening almost as fast as our editors find out.

**Arcade Express** will never be available on any newsstand, but you can get it home delivered for a substantial saving over the single-copy price of \$1.50. **Get six months of Arcade Express—13 bi-weekly issues—for just \$15.00 (save \$4.50) or subscribe for a full year—that's 26 issues—for the low price of \$25 (save \$14.00).**

## Join the Electronic Gaming Elite—Subscribe Today

Mail to: **Arcade Express**  
Reese Publishing Co.  
235 Park Avenue South  
New York, N.Y., 10003

Yes! Make me a **charter subscriber** to Arcade Express!

- Send me six months (13 issues) of Arcade Express for \$15.00 (save \$4.50)
- Send me a full year (26 issues) of Arcade Express for \$25.00 (save \$14.00)

Name ..... Please Print

Address .....

City ..... State ..... Zip .....

Enclosed is my payment of .....

Please make all checks payable to: Reese Publishing Company



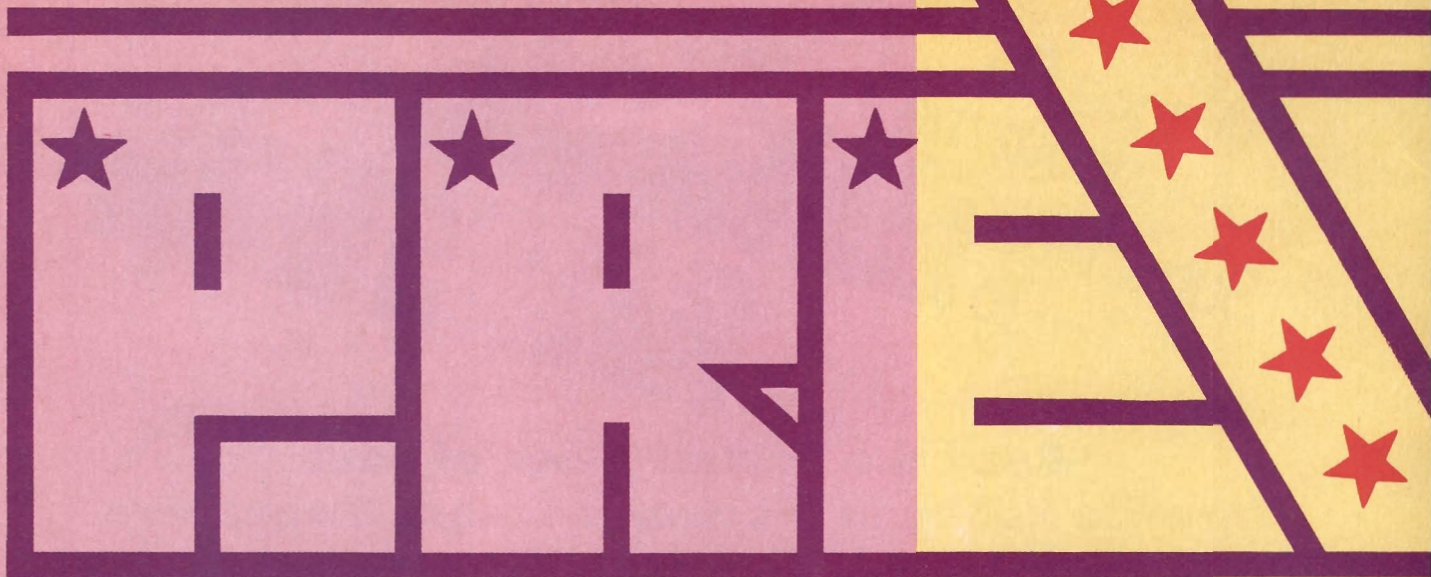

## Here Are the Cartridges We'll Soon Be Playing

by ARNIE KATZ & BILL KUNKEL

**W**hat a difference a couple of years make! Videogamers used to bite their nails down to the quick in anticipation of each new cartridge release. Such behavior was only to be expected, of course. There were not many new cartridges coming out and the existing game libraries were still small enough that every additional title was a landmark event.

Over the next six months, arcaders' biggest problem won't be locating enough new games to scratch that videogaming itch, but rather, finding some way to store all the new ones!

Manufacturers are expecting to sell more than twice as many videogame cartridges this year compared to last—that's more than 60 million games—but there will be decidedly more different cartridges competing for the electronic gaming dollar. Owners of the Atari VCS, for instance, will be able to choose from among 100 games making their debut in 1982. Prospects for the Intellivision aren't quite that lush, but with companies like Activision, Coleco and Imagic getting into the business of making games for the Mattel machine, owners of that system won't exactly be hurting.

The most exciting Atari VCS development is the Supercharger from a new West Coast company called Arcadia. It's a RAM, not a ROM cartridge, such as the ones on which game programs are currently encoded. It has the effect of greatly improving the on-screen graphic resolution of the

VCS while also making it possible to have more objects whizzing around the screen at the same time without producing the flickering that mars some of the more ambitious VCS-compatible games.

The Supercharger plugs into the slot provided for ordinary ROM carts on the VCS. Once installed, a standard audio tape recorder can be attached to the Supercharger. Arcadia plans to market its own line of VCS games on tape in time for this year's gift-giving season. Several other companies have informed **EG** that they

will also be targeting this new market in the near future.

Even as Supercharger bids fair to keep the VCS alive and kicking for at least several years to come, Atari is now ready to bring out its much-discussed Supergame, now also





# OF THE NEW VIDEOGAMES

known as the 5200. There'll be a host of new games especially designed for the unit, too, including an absolutely sensational version of **Pac-Man**.

Coleco's new system will probably turn out to be the Supergame's most potent competitor at the premium-priced end of the spectrum. The company expects to have units and compatible cartridges in the stores by the time you're reading this issue of **EG**. **Donkey Kong** will be the game packaged with each ColecoVision. Coleco is also steaming ahead with its plans to produce cartridges for both the Atari VCS and Mattel Intellivision systems.

Another new system is the Emerson Arcadia 2001. It is a standard programmable system (4K resident memory or less with low-resolution graphics), with a couple of dozen game cartridges ready for play. It is expected to sell for under \$200.00, quite a bargain for those looking to get into home arcading for the first time.

Vec-Trex, by GCE, is yet another stunning new game machine. You won't need the family TV set for this one, though, because it is built around a black and white vector graphics monitor that produces super visuals on a par with such coin-op classics as **Asteroids**. Look for a complete—and exclusive—profile of Vec-Trex and seven of its game cartridges in the November issue of **Electronic Games**.

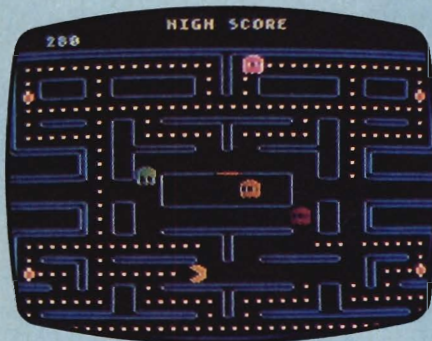

**PAC-MAN (5200)**

Talking videogames will be a big item soon. Both Mattel and Odyssey will be bringing out voice synthesis modules for their systems in the very near future. And naturally, there will be games available for both systems which will capitalize on their ability to speak recognizable words and sentences. Atari, not to be left out, is mulling the idea of adding a voice synthesizer to its line of 5200 gadgets.

Now, here's the company-by-company rundown on what the videogame makers have planned for all of us in the near future:

## **ATARI**

The number-one videogame company has been very busy lately, producing both a new, more sophisticated game playing system, the 5200, and a raft of cartridges for the VCS, including at least one remake of an old title (a new baseball simulation) and a game based on a program designed for the 400/800 computer series, **Star Raiders**. The latter title uses an Intellivision-style overlay and the old keypad controllers in conjunction with the joystick, allowing gamers to use shields, computer tracking and make hyperspace jumps from a cosmic grid.

Initial releases for the 5200, which is non-compatible with either the VCS or the 400/800 computers, will include a dozen titles evenly mixed between super-realistic sports simulations and popular arcade titles such as **Missile Command**, **Pac-Man** and **Centipede**. Also on display was a special trac-ball controller for the 5200.

## **INTELLIVISION**

Besides Intellivision-compatible cartridges from Imagic, Activision and Coleco, Mattel Electronics itself is releasing a swarm of new titles. These include: **Frog Bog**, **Utopia**, **Space Hawk**, **Night Stalker** (a maze adventure), **Advanced Dungeons & Dragons** and three **Tron** titles; **Deadly Discs**, **Solar Sailor** and **Mazatron**.

The Intellivoice is all dressed up and set to strut with an initial trio of games. The best may be **Space Spartans**, a sort of **Space Battle** with voice over—





# VIDEO LIVERY

BUY 5 AND GET 5% DISCOUNT

BUY 10 AND GET 10% DISCOUNT

## Atari

<b>Master Component</b> . . . . . call	Fishing Derby . . . . . 23.95
Combat . . . . . 22.95	Skating . . . . . 23.95
Air-Sea Battle . . . . . 22.95	Bridge . . . . . 32.95
Space War . . . . . 12.95	Tennis . . . . . 23.95
Outlaw . . . . . 22.95	Laser Blast . . . . . 23.95
Slot Racers . . . . . 22.95	Freeway . . . . . 23.95
Canyon Racers . . . . . 22.95	Kaboom . . . . . 23.95
Super Breakout . . . . . 31.95	Stampede . . . . . 23.95
Defender . . . . . 37.95	Ice Hockey . . . . . 32.95
Warlords . . . . . 31.95	Barnstorming . . . . . 33.95
Indy 500 (w/controllers) . . . . . 39.95	Grand Prix . . . . . 33.95
Street Racer . . . . . 12.95	Chopper Command . . . . . 33.95
Adventure . . . . . 31.95	Starmaster . . . . . 33.95
Demons to Dragons . . . . . 26.95	

<b>Pele's Soccer</b> (SALE) 12.95	
Backgammon . . . . . 26.95	
<b>3-D Tic Tac Toe</b> (SALE) 12.95	
Basic Programming . . . . . 26.95	
Video Olympics . . . . . 22.95	
Breakout . . . . . 22.95	
Home Run . . . . . 12.95	
Basketball . . . . . 22.95	
Football . . . . . 12.95	
Human Cannonball . . . . . 12.95	
Bowling . . . . . 22.95	
<b>Sky Diver</b> (SALE) 12.95	
Circus Atari . . . . . 26.95	
Superman . . . . . 31.95	
Space Invaders . . . . . 31.95	
Night Driver . . . . . 26.95	
Golf . . . . . 22.95	
Maze Craze . . . . . 26.95	
Video Checkers . . . . . 22.95	
Dodge'em . . . . . 22.95	
Missile Command . . . . . 31.95	
Othello . . . . . 22.95	
Fox Bat (Dec.) . . . . . 37.95	
Surround . . . . . 12.95	
Game of Concentration . . . . . 22.95	
Codebreaker . . . . . 22.95	
Video Chess . . . . . 26.95	
PacMan . . . . . 37.95	
Video Pinball . . . . . 31.95	
Asteroids . . . . . 37.95	
Berserk (Aug.) . . . . . 31.95	
<b>Casino</b> (SALE) 22.95	
Haunted House . . . . . 26.95	
Yar's Revenge . . . . . 31.95	
Adventure I (Nov.) . . . . . 37.95	
Adventure II (Nov.) . . . . . 37.95	
Math Grand Prix . . . . . 22.95	
Star Raiders (Sept.) . . . . . 37.95	
Hangman . . . . . 22.95	
Brain Games . . . . . 22.95	
Action Pak . . . . . 49.95	
Racing Pak . . . . . 49.95	
Back to School Pak . . . . . 49.95	
Street Racer . . . . . 12.95	
Baseball . . . . . 37.95	
Volleyball . . . . . 37.95	
Frog Pond . . . . . 37.95	
Phoenix (Dec.) . . . . . call	
Vanguard (Dec.) . . . . . call	
Raiders of the Lost Ark (Dec.) . . . . . 37.95	

<b>Imagic</b>	
<b>Fits Atari</b>	
Trick Shot . . . . . 24.95	
Demon Attack . . . . . 31.95	
Star Voyager . . . . . 31.95	
Atlantis . . . . . 31.95	
Cosmic Ark . . . . . 31.95	
Fire Fighter . . . . . 24.95	
Riddle of the Sphinx . . . . . 31.95	
Video Action Center . . . . . 31.95	

<b>Imagic</b>	
<b>Fits Mattel</b>	
Demon Attack (Oct.) . . . . . 34.95	
Atlantis (Oct.) . . . . . 34.95	
Swords & Sorcerers (Oct.) . . . . . 34.95	
Micro Surgeon . . . . . call	
Beauty and the Beast . . . . . call	

<b>Mattel</b>	
<b>Master Component</b> . . . . . call	
AC Adaptor . . . . . 9.95	
Auto Racing . . . . . 32.95	
NHL Hockey . . . . . 28.95	
Las Vegas Roulette . . . . . 17.95	
ABPA Backgammon . . . . . 22.95	
Checkers . . . . . 17.95	
Tank Battle . . . . . 32.95	
Electric Co. Word Fun . . . . . 17.95	
Horse Racing . . . . . 28.95	
Basketball 2 . . . . . 39.95	
Computer Gin . . . . . 49.95	
Horse Race Analyzer . . . . . 79.95	
NASL Soccer . . . . . 28.95	
Computer Backgammon . . . . . 99.95	
Tennis . . . . . 28.95	
P.G.A. Golf . . . . . 28.95	
U.S. Ski Team Skiing . . . . . 32.95	
Sea Battle . . . . . 39.95	
Boxing . . . . . 32.95	
Dungeons & Dragons . . . . . 49.95	
Computer Chess . . . . . 129.95	
Bowling . . . . . 39.95	
Basketball . . . . . 29.95	
NFL Football . . . . . 32.95	
Space Battle . . . . . 32.95	
Electric Co. Math Fun . . . . . 17.95	
Major League Baseball . . . . . 32.95	
NBA Basketball . . . . . 32.95	
Baseball . . . . . 39.95	
Hockey . . . . . 29.95	
Championship Baseball . . . . . 79.95	
Championship Football . . . . . 79.95	
Intellivoice . . . . . 99.95	
PBA Bowling . . . . . 32.95	
Sub-Hunt . . . . . 32.95	
Chess (Sept.) . . . . . 55.95	
Space Spartans (Aug.) . . . . . 43.95	
Astro Smash . . . . . 32.95	
Duet Trac . . . . . 59.95	
Snafu . . . . . 32.95	
Space Armada . . . . . 32.95	
Arcade (Triple Action) . . . . . 28.95	
Dallas Computer Game . . . . . 49.95	
Bomb Squad (Aug.) . . . . . 43.95	
B-17 (Aug.) . . . . . 43.95	
Space Hawk . . . . . 39.95	
Utopia . . . . . 39.95	
Star Hawk . . . . . 39.95	
Star Strike . . . . . 39.95	

<b>Accessories</b>	
<b>Le Stick</b> . . . . . 39.95	
Driving Controller Pair . . . . . 21.95	
Paddle Controller Pair . . . . . 21.95	
Keyboard Controller Pair . . . . . 21.95	
Joystick Controller Single . . . . . 10.95	
AC Adaptor . . . . . 9.95	
Switch Box . . . . . 9.95	
Atari Game Program Case . . . . . 9.95	
Atari Modular Cartridge Library . . . . . 14.95	
Atari Game Center . . . . . 39.95	

<b>Activision</b>	
Dragster . . . . . 23.95	
Boxing . . . . . 23.95	
Checkers . . . . . 23.95	
Pitfall . . . . . call	
Magamania . . . . . call	

Speed Freak . . . . . 29.95	Big League Baseball . . . . . 34.95
Competition Football . . . . . 22.95	Astroblast . . . . . 34.95
Synsonic's Drums . . . . . 149.95	Dark Raven (Sept.) . . . . . 40.95
Minotaur (1983) . . . . . 43.95	International Soccer (Sept.) . . . . . 34.95
Frog Bog . . . . . 22.95	Mattel Soft Dust Cover . . . . . 9.95
Land Battle (1983) . . . . . 43.95	
Royal Dealer (Oct.) . . . . . 22.95	
Reversi . . . . . 22.95	
Night Stalker . . . . . 39.95	
Pin Ball (Oct.) . . . . . 28.95	
TRON-Deadly Disc . . . . . 32.95	
TRON-Mazatron (Oct.) . . . . . 32.95	
TRON-Solar Sailor (Oct.) . . . . . 43.95	
Pocket Dungeons & Dragons . . . . . 24.95	
Armor Battle . . . . . 29.95	
Long Bomb Football . . . . . 29.95	
Lock 'n' Chase . . . . . 39.95	
Card Fun . . . . . 20.95	
Las Vegas Poker & Black Jack . . . . . 15.99	
Major League Baseball . . . . . 29.99	

<b>Odyssey</b>	
<b>Master Component</b> . . . . . call	
Video Module . . . . . 89.95	
Sid the Spellbinder (Voice) . . . . . 49.95	
Numbers and Nimble Ned (Voice) . . . . . 49.95	
Type and Tell (Voice) . . . . . 39.95	
K.C.'s Crazy Chase (Voice) . . . . . 34.95	
Smithereens (Voice) (Nov.) . . . . . 34.95	
Acrobat (Voice) (Nov.) . . . . . 34.95	
Creature (Voice) (Nov.) . . . . . 34.95	
Arcade (Voice) (Nov.) . . . . . 34.95	
Las Vegas Blackjack . . . . . 22.95	
Football . . . . . 22.95	
Armored Encounter/Sub Chase . . . . . 22.95	
Bowling/Basketball . . . . . 22.95	
Math-A-Magic/Echo . . . . . 22.95	
Computer Intro . . . . . 39.95	
Match/Logix/Buzzword . . . . . 22.95	
Baseball . . . . . 22.95	
Computer Golf . . . . . 22.95	
Cosmic Conflict . . . . . 22.95	
Take the Money & Run . . . . . 14.95	
I've Got Your Number . . . . . 26.95	
Invaders from Hyperspace . . . . . 22.95	
Thunderball . . . . . 22.95	
Showdown in 2100 A.D. . . . . 22.95	
War of Nerves . . . . . 22.95	
Alpine Skiing . . . . . 22.95	
Helicopter Rescue/Out of This World . . . . . 22.95	
Hockey/Soccer . . . . . 22.95	
Dynasty . . . . . 14.95	
Volleyball . . . . . 22.95	
Foosball . . . . . 14.95	
Pocket Billiards . . . . . 22.95	
Pachinko . . . . . 22.95	
Slot Machine . . . . . 22.95	
Blastout . . . . . 22.95	
Alien Invaders . . . . . 22.95	
Quest for the Rings . . . . . 49.95	
UFO . . . . . 29.95	
Conquest of the World . . . . . 49.95	
Monkeyshines . . . . . 29.95	
Message Center . . . . . 22.95	
Great Wall Street Fortune Hunt . . . . . 49.95	
K.C. Munchkin . . . . . 29.95	
TV/Game Switch . . . . . 14.95	
Pickaxe Pete . . . . . 32.95	

<b>U.S. Games</b>	
<b>Fits Atari</b>	
Space Jockey . . . . . 24.95	
Sneek & Peek . . . . . 29.95	
Word Zapper . . . . . 29.95	
Commando Raid . . . . . 29.95	
Missile Intercept (Aug.) . . . . . 29.95	
Catch Aug. . . . . 29.95	
The Fly (Sept.) . . . . . 29.95	
Darts (Sept.) . . . . . 29.95	
Towering Inferno . . . . . call	

<b>Apollo</b>	
<b>Fits Atari</b>	
Sneek & Peek . . . . . 22.95	
Space Chase . . . . . 31.95	
Space Cavern . . . . . 31.95	
Rocketball . . . . . 31.95	
Lost Luggage . . . . . 31.95	
Lock Jaw (Sharks) . . . . . 31.95	

<b>Colecovision</b>	
<b>Fits Coleco</b>	
<b>Master Component</b> . . . . . call	
Conversion Module (For Atari Cartridges) . . . . . 89.99	
Controller . . . . . 32.99	
Donkey Kong . . . . . 33.99	
Turbo (Oct.) . . . . . 89.99	
Space Fury (Oct.) . . . . . 33.99	
Venture . . . . . 33.99	
Mouse Trap . . . . . 33.99	
Lady Bug . . . . . 33.99	
Cosmic Avenger (Oct.) . . . . . 33.99	
Zaxxon . . . . . 59.99	
Las Vegas (Oct.) . . . . . 33.99	
Horse Racing . . . . . 33.99	
Smurf Action . . . . . 33.99	
Carnival . . . . . 33.99	

<b>Coleco</b>	
<b>Fits Atari</b>	
Donkey Kong . . . . . 33.99	
Zaxxon (Oct.) . . . . . 33.99	
Turbo (Sept.) . . . . . 33.99	
Venture . . . . . 33.99	
Mouse Trap (Aug.) . . . . . 33.99	
Smurf Action (Aug.) . . . . . 33.99	
Carnival . . . . . 33.99	

<b>Network</b>	
<b>Made by Mattel to fit Atari games.</b>	
Pro Football . . . . . 34.95	
Space Attack . . . . . 34.95	
Tank Battle . . . . . 34.95	
TRON-Deadly Discs (Aug.) . . . . . 40.95	
Lock 'n' Chase (Oct.) . . . . . 40.95	
Frogs & Flies . . . . . 30.95	

## Bally, Astrovision, Astrocade

<b>Master Component</b> . . . . . call	VIC Avenger . . . . . 29.95
(Includes 4 built-in games)	Superslot . . . . . 29.95
Hand Controls (ea.) . . . . . 27.50	VIC Super Alien . . . . . 29.95
ZZZZzap/Dodgem . . . . . 24.95	Jupiter Lander . . . . . 29.95
Seawolf/Missile . . . . . 24.95	Draw Poker . . . . . 29.95
Panzer Attack/Red Baron . . . . . 29.95	Midnight Drive/Road Race . . . . . 29.95
Clowns/Brickyard . . . . . 29.95	Radar Rat Race . . . . . 29.95
Star Battle . . . . . 24.95	Raid on Fort Knox . . . . . 29.95
Astro Battle . . . . . 29.95	Sargon II Chess . . . . . 39.95
Dog Patch . . . . . 29.95	Pinball Spectacular . . . . . 39.95
Galactic Invasion . . . . . 29.95	GORF . . . . . 39.95
Space Fortress . . . . . 29.95	Omega Race . . . . . 39.95
Grand Prix . . . . . 29.95	Adventure Land Adv. . . . . 39.95
Pirate Chase . . . . . 29.95	Pirate Cove Adventure . . . . . 39.95
Munchie . . . . . 34.95	Mission Impossible Adv. . . . . 39.95
The Wizard . . . . . 34.95	The Count Adventure . . . . . 39.95
Solar Conqueror . . . . . 34.95	Voodoo Castle Adv. . . . . 39.95
Cosmic Raiders/Defenders . . . . . 34.95	The Sky is Falling . . . . . 39.95
Bezbo! Tennis/Hockey/ Handball . . . . . 29.95	VIC 20 Super Expander . . . . . 69.95
Football . . . . . 29.95	Programmers Aid Cart. . . . . 59.95
Bally Pin . . . . . 29.95	Intro to BASIC Programming Part I . . . . . 24.95
Bingo Math/Speed Math . . . . . 24.95	Recreation Program Pk. . . . . 59.95
Letter Match/Spell 'n' Score/Crosswords . . . . . 29.95	Home Calculation Program Pack . . . . . 59.95
Music Maker I . . . . . 59.95	Programmable Character Set/ Gamegraphics Editor . . . . . 14.95
Biorhythm/Calendar . . . . . 29.95	VIC Term I Terminal . . . . . 9.95
Coloring book with light pen . . . . . 59.95	VIC Graphic Printer Paper 15.00
Coloring book . . . . . 34.95	VIC Printer Ribbon Cart. . . . . 9.95
Amazin Maze/Tic-Tac-Toe . . . . . 24.95	
Black Jack/Poker . . . . . 29.95	
Acay Oucey . . . . . 29.95	
Quest for the Orb . . . . . 34.95	
Pirate's Chase . . . . . 29.95	
The Incredible Wizard . . . . . 34.95	

<b>Bally Computers</b>	
<b>Z Grass Computer/ Keyboard</b> . . . . . call	
Bally Basic (Old) . . . . . 29.95	
Bally Basic (Demo) . . . . . 29.95	
Bally Basic/Audio Interface . . . . . 59.95	
Max (Robot from Space)/ Horse Race . . . . . 10.95	
Clue/Flying Ace . . . . . 10.95	
Maze Race/Obstacle Course/Space Chase . . . . . 10.95	
Slot Machine/Perversion . . . . . 10.95	
Music Composer/Yahtzee . . . . . 10.95	
Notematch . . . . . 10.95	
Guitar Course/Tuning/Note Match/Chord Progressing . . . . . 19.95	
Backgammon/Obstacle Course/ Tournament . . . . . 15.95	
Pack Rat I & II . . . . . 10.95	
Lookout for the Bull I & II . . . . . 10.95	
Whiz Quiz (Trivia) . . . . . 12.95	
Castle of Horror . . . . . 10.95	

<b>Data Age</b>	
<b>Fits Atari</b>	
Encounter at L-5 . . . . . 31.95	
Warlock . . . . . 31.95	
Sssnake . . . . . 31.95	
Airlock . . . . . 31.95	
Survival Run . . . . . 31.95	

<b>Tigervision</b>	
<b>Fits Atari</b>	
King Kong . . . . . 31.95	
Jaw Breakers . . . . . 31.95	
Treshold (Sept.) . . . . . 22.95	
River Patrol (Aug.) . . . . . 22.95	
Marauder (Oct.) . . . . . 22.95	



optionally male or female (the lady speaks more clearly).

Perhaps the most startling revelation from Mattel concerns its 12 *Atari-compatible* (!) titles. Dubbed the "M" network, it adapts a handful of Intellivision faves into VCS format.

### ODYSSEY<sup>2</sup>

Right on the heels of a major setback—the banning of **K.C. Munchkin** as an infringement on Atari's home **Pac-Man** rights—Odyssey has risen like a Phoenix with several major coups.

Most important, at least from the company's standpoint, is that the system and its software library will now be carried in the Sears catalog (which has previously dealt only in those versions of the Atari VCS and the Intellivision). The Sears connection has



UTOPIA

proven immensely valuable to both Atari and Mattel, and this can only bode well for O<sup>2</sup> owners.

More good news comes in the form of an announcement from Imagic, which will soon release an O<sup>2</sup> version of its smash hit, **Demon Attack**. This is the first time an independent software producer has created an Odyssey-compatible game cartridge, more good tidings for the system's fans.

In terms of in-house software development, the latest entry in the classic Master Strategy Series will be a *Sherlock Holmes* mystery contest. Action-game fans will want to check out **Pick Ax Pete**, an excavation/exploration game with charming graphics and strong play.

The Voice unit is now ready to go and it boasts excellent audio capabilities. Initial game entries include the wickedly clever sequel to the banned gobble game, an entirely new contest entitled **K.C.'s Crazy Chase** and the as-yet-unpreviewed **Smithereens**. These voice games play with or without the voice synthesis system itself! You won't hear the cute narration and commentary, but all the arcade-



COSMIC RAIDERS

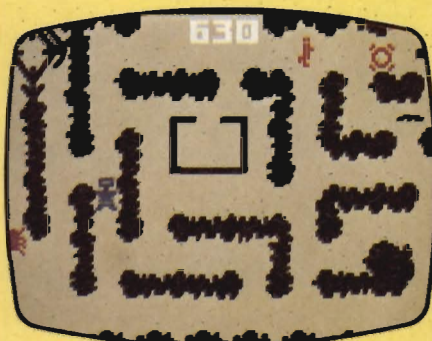

NIGHT STALKER

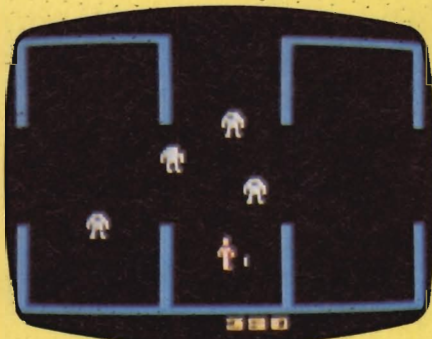

BERZERK (2600)

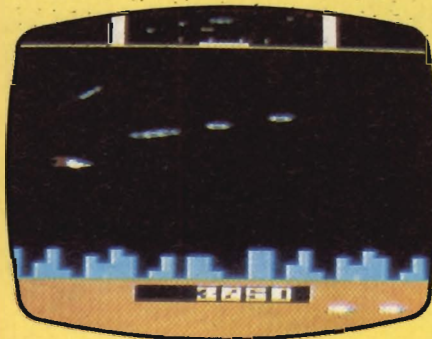

DEFENDER (2600)

type bleeps and boops will turn up, right on cue.

### COLECO

There isn't much further word from Coleco on its super-sophisticated ColecoVision, or its VCS emulator (which allows the system to play Atari 2600-format cartridges). The company lost

two highly-prized designers, however, when the Kitchen brothers, who did Coleco's **Donkey Kong**, bolted to Activision's new East Coast design division (see ACTV section).

The Coleco people have been busily beating the bushes for talent, however, and look to perhaps release even more ColecoVision systems hardware and a greater variety of software than was previously anticipated.

It has also been rumored that the next peripheral for the ColecoVision will be a plug-in keyboard that will give the system virtual computer status.

### ASTROCADE

Sporting a new name and a fantastic system-seller in **The Incredible Wizard** (from **Wizard of Wor** designer Bob Ogdon), Astrocade promises an improved keyboard (the Z Grass 200) and



DEMON ATTACK (INTELLIVISION)

a batch of new games including **Conan the Barbarian** and **G.I. Joe**. The latter is a highly dressed-up version of the independently-produced **Artillery Duel**. Astrocade has also been talking with other underground Astro game designers, such as Wavemakers and Arcadians which began programming games on cassette a few years ago when Bally retrenched with the system.

New Astrocade releases include **Soccer**, **Solar Conqueror** and **Cosmic Raiders** with voice synthesis reportedly on the way.

### PARKER BROTHERS

Already shipping copies of its prestigious debut title, **The Empire Strikes Back**, Parker is jumping into the software wars in earnest with its follow-up title **Frogger**, a graphically astonishing recreation of the Sega coin-op favorite. Also from the arcades comes **Amidar**, a maze chase. **Spiderman** will swing out of Marvel Comic Books and onto TV gaming screens in a vertically-scrolling battle with the Green Goblin.

The second batch of VCS-



## MINE STORM (VECTREX)

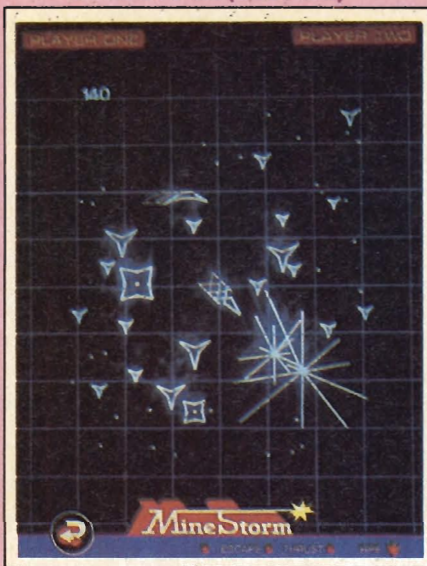

compatible games will include **Super Cobra** (like *Amidar*, a Konami coin-op), a home version of Gottlieb's **Reactor** and Nintendo's **Sky Skipper**. Future properties will involve videogame versions of *James Bond* and *Jaws*.

## MCA

One of this year's real surprises is the entry of movie/TV titan MCA into the fray. No specific cartridges have been mentioned, but spokesmen indicated that most of the titles would be based on movies owned by the company. The company has also promised to produce versions of its games for as many systems as feasible.

## ACTIVISION

Two new smashes highlight the latest news from the leading independent software company: Steve Cartwright's **Megamania** (a wild and crazy outer space shoot-'em-up) and Dave Crane's epic videogame/adventure, **Pitfall**.

The other big doings concern the translation of several ACTV hits, such as **Stampede**, into the Intellivision format.

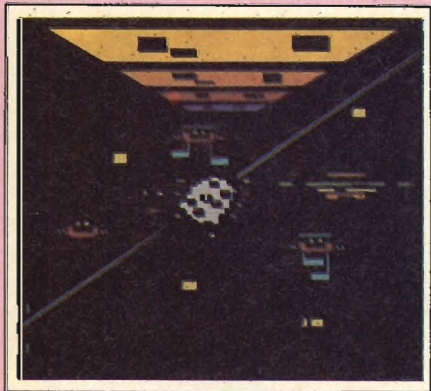

CROSS FIRE

## GAMES BY APOLLO

A quartet of new titles are now in the stores from this Texas-based producer of high-skill VCS-compatible games. **Space Caverns**, an invasion game with horizontal as well as vertical fire; **Lost Luggage**; the baffling **Racquetball** and **Shark Attack**, a maze chase contest brings the Apollo library up to a half-dozen titles.

## VECTREX

GCE, producer of the highly successful series of game watches and calculators, has entered the videogame market with one of the field's most unique items, a vector-graphics monitor that uses plug-in game cartridges, console controllers and color overlays to get within breathing distance of coin-op quality.

Initial games involve a *Star Trek* contest and an eye-popping auto-race called **Hyper Chase**. The outfit retails at around \$200.

## ARCADIA

The Supercharger, which comes with an excellent introductory game, **Phaser Patrol**, will sell for about \$70. Future games such as the invasion-cutie, **Communist Mutants from Outer Space**, will sell for \$15 each. This is a true VCS breakthrough, as well as a price break for consumers.

## VIDTEC (U.S. GAMES)

The folks who brought us **Space Jockey** have a whole raft of new games on the way, including: **Towering Inferno** (a helicopter rescue/fireman game), **Word Zapper** (an education/arcade charmer), the hide and seek style **Sneak 'n Peek** and **Gopher Attack**. All games in VCS format.

## DATA AGE

Another new company joining the softstakes with VCS cartridges, Data Age has some impressive games in its line-up. Initial releases are **Encounter at L-5**, **Airlock**, **Survival Run**, **Sssnake** and **Warplack**.

## TIGERVISION

A potential heavyweight in the VCS software explosion, Tigervision is producing 2600 versions of the On-Line computer classics **Jawbreaker** and **Threshold**. Both adaptations are brilliant. *Jawbreaker* is perhaps the most original maze-chase game ever seen. Coming soon is a VCS version of **Marauder**, after which **King Kong** and **River Patrol** will hit store shelves.

## CBS VIDEOGAMES

That's right, CBS, the folks who brought you all those fine—and plenty of not-so-fine—TV shows, is covering all bets by producing a line-up of VCS and Intellivision-format videogames. Initial releases will be **Wizard of Wor** and **Gorf**, with many of the Midway designers working on the translations.

For 1982, CBS expects to release three VCS games, with Intellivision games to follow.

## TELESYS

Basing its strategy on the notion that "less is more" Telesys plans to produce no more than three or four games a year, with heavy promotion given to each title. By keeping its catalog streamlined, Telesys hopes to





avoid falling victim to a possible glut in the VCS software market.

Using the Activision example as a guiding light, Telesys plans to market games characterized by lots of visual appeal and basic play mechanics. The first entry is the off-beat **Fast Food**, in which the gamer controls a set of hungry choppers and scarfs down every bit of horizontally-scrolling junk food (everything from pizza to root beer) that flies across the screen. But if you wolf down three of the dreaded "purple pickels", the game ends. The second entry will be **Coconuts**, in which a pitch helmet-wearing, umbrella-carrying on-screen character must avoid the rain of coconuts being hurled from the trees above by a mischievous monkey named **Coco**—a sort of reverse-**Kaboom!**.

### SPECTRAVISION

This New York-based company has a batch of promising titles up its sleeve, such as **Planet Patrol**, an action adventure that scrolls smoothly and features docking, day and night play (it

gets dark pretty quickly on this planet) and even two types of obstacles—meteor-protected enemy rockets and a trio of debris-missiles, which the player must dodge as your craft is hurled through space.

The other new entry is **Gangster Alley**, a video version of those test streets police must cross, where targets suddenly appear from behind windows. The problem: distinguishing the villains from the occasional innocent. The object, of course, is to hit the bad guys and not the honest citizens. The action is enlivened by a bomber who zips back and forth across the top of the playfield, periodically raising his arm to hurl a bomb. Using a sighting cursor, the player must eliminate him before he lets fly with the explosive.

Future releases (all VCS-format) include: **Tape Worm**, **China Syndrome**, and a space shoot-out called **CrossFire**.

PICK AXE PETE!

### GALAXIAN (5200)

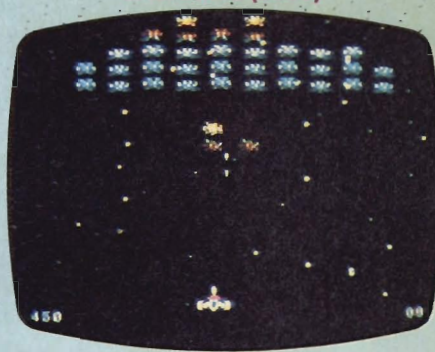

### TWENTIETH CENTURY FOX

Here's still another film producer attempting to make it in the programmable videogame jungle. Using designers from Sirius Software (a leading light in the computer software field), 20th hopes to make a significant dent in this crowded field.

Fox will jump into the VCS-compatible software market with four titles to be released during the Christmas season.

### EMERSON ARCADIA 2001

Not to be confused with the other Arcadia, this product is a new standard programmable system complete with a catalog of 20 cartridges. These range from sports simulations such as **Bowling**, **Football** and **Baseball**, to arcade contests like **Space Raiders** (a horizontally-scrolling science fiction shoot-out) and the maze chase game **Cat Trax**.

The two controllers are Intellivision styled, but with an optional shaft that turns the direction disk into a joystick. The console is compactly constructed with cartridge slot and a quintet of buttons controlling reset, game selection, options, starts and power. Games will come with overlays that slide over the controller keypad.

The Arcadia 2001 is aimed at consumers who want a high-powered (32K RAM) system that competes squarely with the "big four" in terms of price and versatility. In addition, the 2001 is portable in that it is significantly smaller than any other system and can operate on an external 12 volt DC source such as a power belt or in an automobile, RV or boat.

### IMAGIC

One of the most impressive line-ups in the software explosion of 1982 belongs to this high-class operation. While **Demon Attack** continues to lead

*Continued on page 66*



# HOW TO CHEAT AT VIDEO-GAMES

## Tricks of the Trade Revealed

By BILL HEINEMAN

**N**obody's perfect. The programmers and design teams at companies such as Atari, Astrocade, Activision, Intellivision, and Odyssey labor long and hard to fine tune their videogames. Still, human error, blended with the maddening logic of a computer, can create some unexpected and strange variations in otherwise ordinary cartridges.

Every gamer knows by now, for

example, that if the reset button on Atari's VCS version of **Space Invaders** is held down while the game is shut off then switched back on, the hybrid variation that emerges gives players machine gun-like rapid fire. Essentially, this quirk in the program allows gamers to launch two missiles for every one that would ordinarily be fired. The only problem here is that if you shoot more than one invader at the same time, you will only

will only cop points for the *least* valuable alien.

There's also an interesting feature in the VCS **Breakout**, though it can be used for practice. Select any one-player version that has the "catch" option. Play the game normally until you're down to the last ball. Catch the final ball on the paddle and hold it there. Press the game select switch and release the ball. The game will go into its color-shifting routine as if in the display mode, but the ball that has just been set free will behave as if it's in the middle of a game. You won't collect any points for any bricks destroyed this way, unfortunately.

Now let's say that last ball eludes the paddle and passes off the base of the screen. Game over, yes? Nope. The ball will continue straight down until it reappears at the top of the playfield! It will then hit the wall just above the scoreboard, bounce back up through the screen's ceiling and scroll onto the base of the field. Presto! You've just earned a free practice game of catch **Breakout**. Even if you destroy all the bricks on the next round, simply catch





paddles appear instead of just one, enabling the gamer to work out on the two-player variation.

Sorry, this computer bug only grants three magical wishes. After that, you start all over again.

Speaking of cheating, let's continue to "bug" Atari because, after all, *their* games cheat! Are those stares of disbelief I see? Nonetheless, it's true—ask anyone who has ever played **Video Chess** or **Backgammon**, both notorious for their tactics. To verify my case, players need only employ the set-up mode that both cartridges possess and program a semi-hard to very difficult chess problem on the *Video Chess* and draw a diagram of each piece's position. Select difficulty level six or seven and make your move. The game will then go into its thinking process for a prolonged period of time. (How much



The VCS sometimes cheats at Video Chess

time. The program ordinarily plays a fair game, but stay alert when engaging in a tussle of Acey-Deucey. That's where the rules dictate that if a one and two are rolled, then the player can use that one and two normally and can choose any set of doubles for the free move. After this, the player will again get to

roll the dice, and should a one and two turn up again, the bonanza renews itself. The game cheats quite discreetly. To bring it out into the open, pieces must be set up so that all the human player's white men are in the computer's inner table. The player then places the red computer men on the bar, and maneuvers his pieces so that the red men are trapped on the bar. At this point, the player should start the contest by giving the red men an Acey-Deucey.

The computer will soon discover it can't use the one or the two so it will then pick its best doubles. The computer will find that the numbers one through six can't be used because none of its men can move with that number. At this point the computer crosses its joysticks and hopes the player is a sheep—because it will flat-out attempt to fleece him by opting for

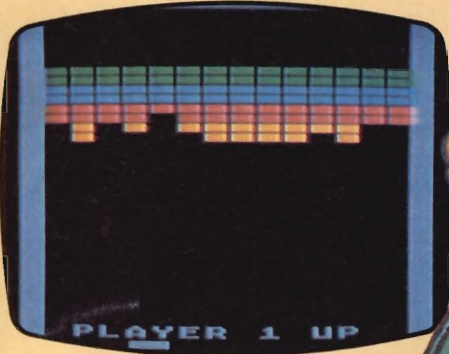

You can play forever in Atari's Breakout

time are we talking about? Well, let's just say it's a good idea to set this up before bed, get a good night's sleep, and check on it in the morning. By the way, leave on the VCR, but *not* your TV.) When the game finally makes its decision, you will find that 95% of the time it has moved not merely a few pieces of its own, but several of *yours* as well! It's a bold devil, you can say that much for it.

*Backgammon* is much more . . . sub-



**If Your Reflexes  
Aren't Quick  
Enough To Beat  
The Most Popular  
Videogames  
It's Time to Use  
Your Wits!**



nine as its doubles to move! Nine, did I say? Hmmm. Have you ever wondered how a six-sided die can possess nine sides? The player, of course, has no such option. Just try choosing a nine. This little glitch only turns up when the computer is trapped in this variation, so it happens infrequently.

**Indy 500** lays claim to a cute little flaw. The way the system confirms that the player has completed a lap is to create a pair of invisible lines, one starting at screen center and going straight up while the other starts at the center and goes straight down. To score a point, and register a completed lap, all the player must do is touch the first line then pass over the second. The process can be repeated endlessly.

Care to drive a friend a little bon-

kers? Just challenge them to a race on Devil's Elbow. As the flag is dropped, turn the first corner and ram your machine straight into the center of the playfield. Spin your vehicle around and around in tiny circles, piling up laps faster than coin-ops eat quarters. This is not recommended for play with friends having martial arts expertise.

Believe it or not, even **Superman** is vulnerable to slight program oddities. How would the average player like to run through the entire scenario without once having to collect the bridge pieces and assemble them—concentrating on capturing Luthor & Co. in the great tradition of superheroic characters? It's easy. Simply hold down the joystick action button as the game begins, prior to

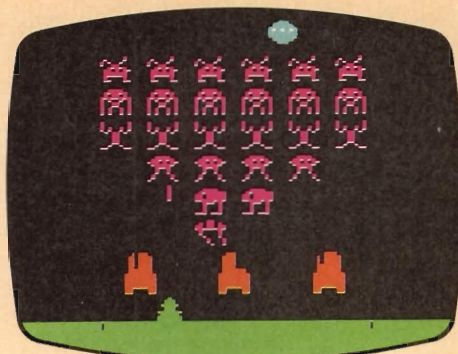

You can rapid-fire in **Space Invaders**.

Superman entering the phone booth. While continuing to depress the button, move the joystick to the right (the depressed button gives the Man of Steel x-ray vision).

Superman will flash in the upper right-hand corner for about three seconds. When the superhero from Krypton disappears, release the action button and fly to the right, directly into the bridge scene, grabbing crooks and ignoring the bridge. The bridge segments can all be found in the blue subway, but construction is optional—it depends how much you enjoy cutting corners. Just put the bad guys in jail and bring in the story—and watch those record times drop!

Okay, now for the real meanies. Plug in the **Combat** cartridge and select any tank game (except those variations with no direct hit). Now hold down the reset switch while you fire at your opponent and release it once the shell reaches your counterpart's war machine. If this manner succeeds, try this variation: Position your tank at any of the maze's four corners. Align the tank with the cannon touching the right wall in perspective to the corner and rub the other wall. This will induce a so-called "hyperspace" jump to the other side of the maze. This stunt will work on any concave corner and is guaranteed to freak out any opponent who has yet to experience the true thrill of deception.

All right, that's a lot of talk about Atari. What about other companies? There's a beaut of a goof in *Odyssey 2's* otherwise excellent **Blockout/Breakdown**. Players in the *Breakdown* mode must destroy every brick on the screen, while the opposition, calling upon a team of construction demons, struggle to rebuild it. The demons reconstruct destroyed blocks by traveling to either the left or right end of the playfield and making physical contact

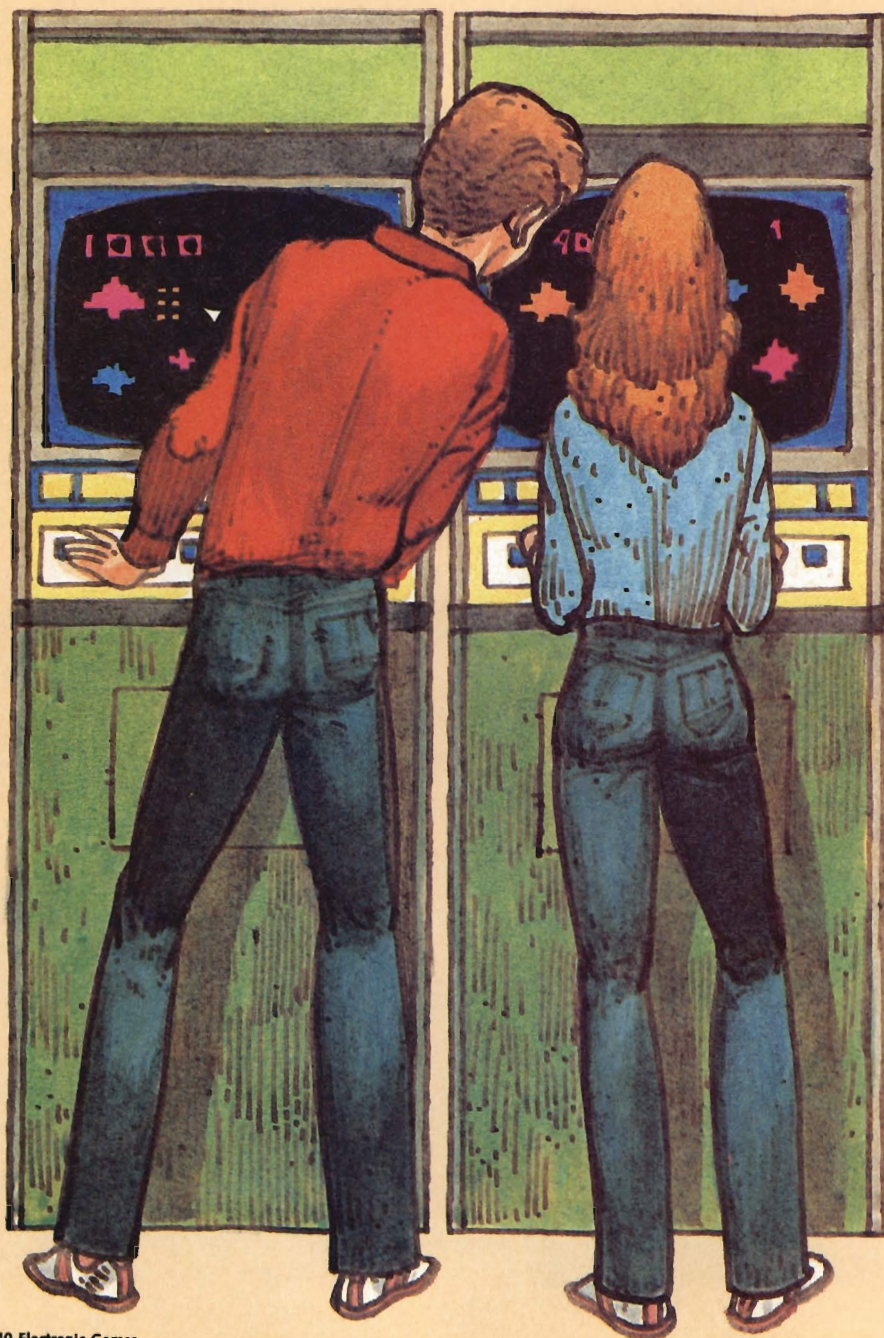



with the power source. This contact allows the demon to create another brick. Contact with the power source, however, includes another benefit—it makes the demon, and the block he inhabits, indestructable. The player controlling demons, therefore, need only move one of the little devils over to the power bar and keep him there. As long as contact is maintained, the demon can never be taken out—and this is a time limit game!

An even more embarrassing glitch turns up in *O<sup>2</sup>'s Soccer/Hockey*. The *Hockey* contest is excellent, but the *Soccer* game is so poorly designed that players can kick goals right through the side of the netting.

What about Activision? Well, *Skiing* can be beaten quite easily by Atari owners possessing the old 2600 console, where the difficulty switches are positioned on the front of the system (owners of the new 2600-A will have some trouble with this technique). Play the game with the difficulty switches in the "B" position. If the on-screen drifts to the edge of the screen and is about to hit an obstacle, quickly flick up the left difficulty toggle and then immediately flick it back down in a smooth motion. As sure as snow in January, the skier is back in the center of the playfield again! With practice, players will be able to cut their skiing time by as much as five seconds in the hard courses and produce lower times overall.

*Laser Blast* also has its own unique quirk. Players flying their UFO's to the lower right-hand side of the screen in the early rounds, when the defensive shield is quite low, are virtually safe from harm since the ground installations are unable to fire at the extreme angle. This is the time to strike! The gun farthest right will be virtually in the UFO's sights. Eliminate that base. Next, depress the button to lower and aim the belly-gun to the left, obliterating the center base, and repeat this procedure on the final base. The instant the final base is blown apart, hit the action button, re-initiating the aim mode and eliminating the necessity of scooting up to the top of the screen. Once the new round is begun, "flick fire" your belly-cannon to the left three times in succession (flick firing means that the cannon is being released and lowered so quickly that the ship never leaves the aim mode). The ability to keep from being pushed upward by the enemy shields will take considerable practice to master, but

once it has been, a million points can be waiting down the road. (Note: this only works on game #1.)

Of course, finding flaws in computer game programs is nothing new. Atari Coin-Op field-tested that original *Asteroids* for months, yet no one ever discovered the one programming flaw that allowed arcade aces to go for hours on two bits—attacking the hunter ships built up bonus points, you see, allowing top guns to wrack up a whole gallery of bonus ships, leaving time to visit the bathroom, grab a soda or whatever.

Even the newest games sometimes

have tiny programming oversights that can spoil an otherwise excellent contest. *Space Jockey* from U.S. Games can be played in version #15 almost forever, simply by staying at the bottom of the playfield and leap-frogging the occasional tank blasts. In some variations, players need only keep moving and keep firing without fear of retribution until the scoring reaches the stratosphere.

So keep looking, keep watching the skies—and, most of all, keep checking out those videogames. You never know *what* you'll find.

G

## Trumping the Arcade Aces

by ARNIE KATZ

Let's face it, all videogamers are not created equal. Some electronic arcaders have quick wits and even quicker reflexes, while others consider the day a success whenever they manage to get their game machine connected and running without a hitch.

If you are so fortunate as to have the mind of an Isaac Asimov and the reactions of a Rod Carew, this section is probably not for you. Just practice, study the strategy hints in *Electronic Games*, and you'll be well on your way to high scores and the acclaim of your peers.

If, however, you only recently found out that many coin-ops have vanity boards because you never score high enough to earn the right to enter your initials, read on.

Although good players will defeat bad ones most of the time—electronic gaming mostly depends on skill, after all—but it takes surprisingly little to tip the balance in favor of even the rottenest joystick wielder. The suggestions that follow will probably do very little to actually boost your point totals, but they might enable you to pull out an occasional victory against that pesky friend who generally trounces you at every game you try.

\* Light the way to success. Like anything else, some care must be taken when playing videogames so that it remains a safe *and* enjoyable pastime. Just as ophthalmologists usually recommend that people not watch television in a completely darkened room, they also suggest that some illumination should be present when playing videogames. To help your opponent save his or her eyesight, buy a nice bright bulb—500 watts ought to do it—and put it in the lamp which is

directly behind where this person will sit while playing. With the lamp's reflection bouncing off the screen, there'll be no danger that your rival will think it's too dark. Alas, this enhancement of eye safety is not without slight cost. It's all too easy to lose track of any rapidly moving object that passes through the "blind spot" such a bright reflection creates on the screen. Well, safety first!

\* The fine-tuning knob is your friend. If you should notice, while your opponent is playing, that the focus, contrast and/or color tint could be improved, adjust the set immediately. Just reach right across the screen and start twiddling those dials!

\* The battle of the sexes. The right salacious remark or off-color joke, whispered in the player's ear at the proper moment, can prove surprisingly distracting. Actual touching of the opponent is frowned upon by the cheater's guild.

\* Pride and joystick. Almost everyone has a garment that they keep stuck back in a drawer because of pure sentiment. It's ripped, frayed and tattered, but it brings back some good memories. That beloved joystick, the first you ever used to play an electronic game, could have the same special meaning to you if you'd let it. Even after hard playing has made it only intermittently responsive, you'll want to keep it in your collection for special occasions. For example, you can give it to that particularly dexterous gamer and say, "Why don't you use my favorite joystick?"

Following these hints may lose you a few friends, but they are guaranteed to win you at least a game or two.

G



# World's Largest Selection of Commercial and Home Video Games and Accessories.

We stock Atari®, Intellivision™, Odyssey2™, Coleco-  
vision™ and Vectrex™ units, cartridges and accessories  
— including a full line of t-shirts, hats, cartridge storage  
cases, controllers, etc.



## This Year:

Coleco™, Imagic™, U.S. Games™ (Vid-Tec)™, Activision™, CommaVid™, Parker Brothers, Computer Magic™, Apollo™, and M Network™ (Mattel) will produce Intellivision™ and Atari® cartridges and we will stock them all! Be the first to receive each new cartridge — write for your catalog now! It tells what's coming, when, and the price. We also stock Ms. PacMan™, DonkeyKong™, Centipede™, Zaxxon™, Dig Dug™, Stargate™, Tempest™, Kangaroo™ and all other great commercial Video games.

## JOIN OUR EXCLUSIVE VIDEO GAME CLUB

Special discounts, contests and a membership card are available to club members.

Send \$2.00 for our latest Catalog & Newsletter telling what's coming in Video Games and club information.

Visa and Mastercard holders may order by phone — NO C.O.D. ORDERS.

For Orders only: 1-800-626-9592 (Mon.-Sat. 9-5 P.S.T.)

For Information call: 1-213-781-1300

(Dealer inquiries welcome.)

# G.A.M.E.S.™

6626A Valjean Avenue • Van Nuys, CA 91406  
Stores throughout Southern California



# Players Guide To Electronic Football





CAN YOU WIN

# THE VIDEO SUPER

## THE BIG KICK-OFF

Cynical commentators often claim that Americans love football because of the rock 'em-sock 'em violence that takes place on the gridiron from the opening kick-off to the gun-shot that signals the end of the final quarter. To judge by the tremendous popularity of electronic football games, however, fans are at least as interested in the subtleties of offensive and defensive strategies, as by the brute force of a jarring tackle.

The interplay between the two platoons is so crucial to the sport, in fact, that few electronic football games even attempt to provide a robot adversary. Unlike the plethora of solitaire sports games, almost all pigskin simulations are for two human coaches. The exceptions are in the microcomputer program category, but the top-quality videogame cartridge suitable for the solo gamer is yet to be produced.

## MATTEL'S NFL FOOTBALL

Put two electronic sports game buffs together in a room, and it won't be long before they're arguing the question of which company makes the best videogame football cartridge. It's an issue that will never be decided, simply because different people want different things out of their games.

It's fairly safe to say, though, that those who are football fans first and videogamers second are apt to

find that **Mattel's NFL Football** for its Intellivision system is far and away the most realistic and comprehensive grid simulation. Although there are only five on-screen

players, the offensive coordinator first pushes the spot on the keypad that corresponds to "run", "kick" or "pass" (It is possible for the quarterback to rush even if a different play is chosen, how-

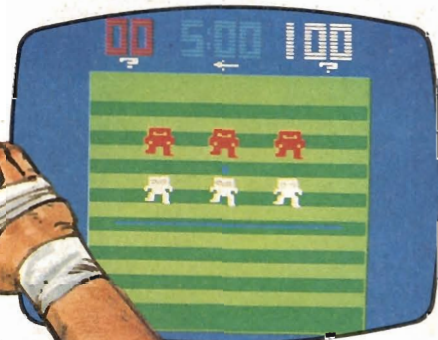

**MATTEL NFL FOOTBALL**

really want to see an electronic football play unfold at the same pace as the typical arcade-style action game? If *NFL Football* has a drawback, it is that the cartridge may strike some gamers as too complicated. Learning the offensive and defensive playbooks requires a little study, and most players will need some time on the practice field before they're able to direct a passing game that connects often enough to be a serious threat to the other team. It is certainly not the best choice for arcaders who

are only mildly interested in the sport or who strongly prefer games which can be thrown into the cartridge slot and played immediately.

Yet for the true connoisseur of pigskin thrills, *NFL Football* will prove very rewarding. It is ideal for league play and looks especially good on a giant-size TV. *NFL Football* is the football videogame cartridge for the true pigskin fan!

## ASTROCADE FOOTBALL

If *Mattel's NFL Football* is the game for those who may

athletes per team and only one of those can be directly controlled by the coach at any one time, this cartridge provides unequalled detail in the area of play-calling. Each electronic Don Shula or Dick Vermeil can choose from a variety of offensive and defensive formations, with a good selection of patterns and coverages.

The process by which an offensive play is entered into the Intellivision gives a fair index of this cartridge's amazing richness. The offen-

ever.) Then he must select one of the nine offensive sets. If it is going to be a pass play, the coach then designates a primary receiver and picks one of the nine passing zones as described in a diagram included with the cartridge.

The game plays at four different speeds, graded from "high school" to "pro". The slowest mode is really only fit for practicing, and even top speed isn't really all that rapid. A few gamers may actually find *NFL Football* a tiny bit slow, but then, would you



# BOWL?

Think You Really Know Your Football? Find Out with These Gridiron Videogames!

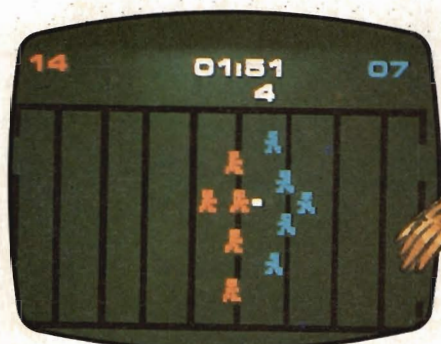

ODYSSEY FOOTBALL!

be more interested in the gridiron than the game board, this cartridge is **Electronic Games'** pick for those whose interests are centered mostly on playing videogames. The reason is that, though **Astrocade Football** is far from simple and includes much of the flavor of the real game, it is considerably easier and quicker to learn than the Intellivision version.

The secret is in the play selection process. Like **NFL Football**, this simulation comes with a little playbook

for the offense (defense is more freewheeling here). The difference is that, in this case, the playbook is only a reminder to which the players may want to occasionally refer. The

real business of deciding what

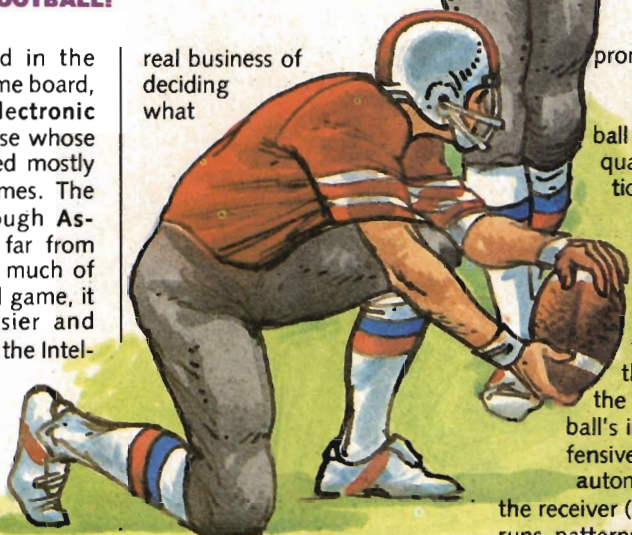

to do after the ball is hiked from scrimmage takes place right on the screen using a straightforward menu-driven system.

The control system also

promotes each play.

Pushing the joystick springs the ball and controls the quarterback's direction of movement.

The knob directs the angle of the passer's arm, thereby governing the flight of the ball, which is thrown by pulling the trigger. Once the ball's in the air, the offensive coach's control automatically shifts to the receiver (the flanker) who runs patterns along the top of the TV display.

Another good point for this game is that it can be played by four instead of two. On defense, each human controls one cornerback, while on of-

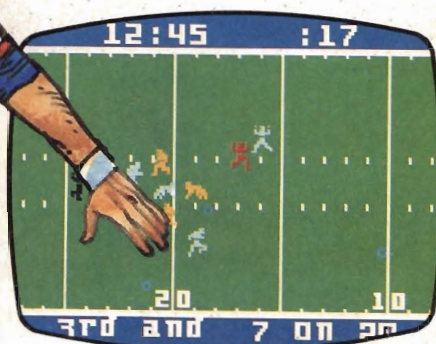

ATARI 2600 FOOTBALL

fense the alternate receiver who runs along the bottom of the screen is under direct control of one of the co-coaches.

## ATARI VCS FOOTBALL

That old devil screen flicker sabotages what would otherwise be a most innovative approach to reproducing football action within the limitations imposed by the VCS' relatively small memory. Movement of the players can be awfully hard to track when the chunky electronic athletes are swarming all over the field.

The cartridge's unique feature is that the goal lines are at the top and bottom of the screen instead of the sides as in the other football videogames. This allows a full field to be displayed, without it having to be as small as it would if oriented convention-

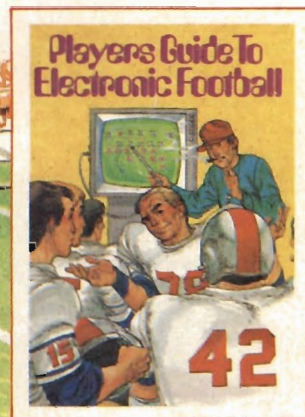



ally on the screen. On the other hand, it would have to be twice as large to give the over-sized players room to maneuver to the same degree as is possible in some other games.

## ODYSSEY'S FOOTBALL!

Almost by definition, a football cartridge for the standard programmable videogame systems (Odyssey, Atari) must be simpler than

one created for the more powerful senior programmables (Astrocade, Intellivision). Viewed in that light, Odyssey's entry is a surprisingly satisfying game.

Oh, it has its limitations.

Lack of a scrolling playfield—a feature of both senior system titles—means that play is more cramped in this version of video gridding. And because the field is small, there is no provision for a first down. A

# INSIDE COMPUTER FOOTBALL

## You Don't Have to Be A Pro to Win!

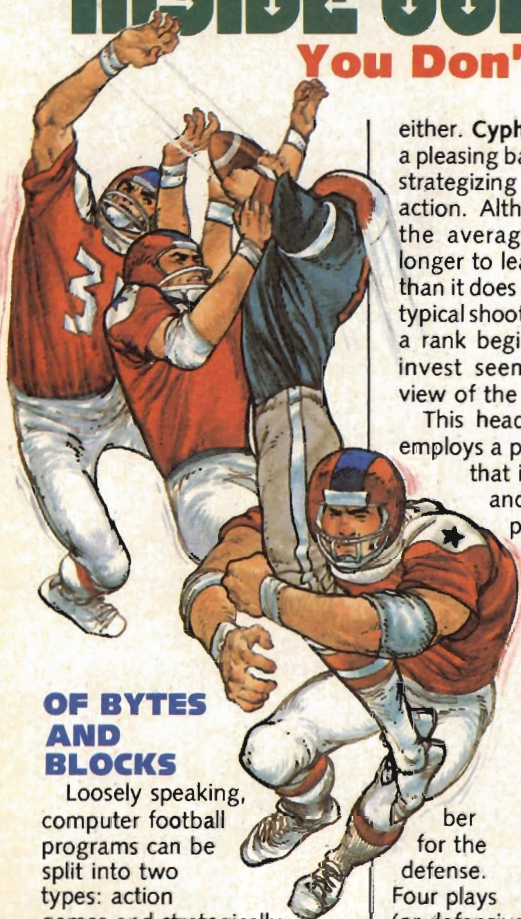

### OF BYTES AND BLOCKS

Loosely speaking, computer football programs can be split into two types: action games and strategically-oriented simulations. Statistical replay games, which are almost a hobby unto themselves with thousands of tabletop coaches from coast to coast, have not yet made much of a dent. (*Computer Quarterback*, by Strategic Simulations, is largely a contest of strategies, though a special disk available from the company puts actual NFL players on the field.)

### ATARI'S CYPHER BOWL

The first gridiron game expressly designed for the Atari 400 and 800 computers resembles the senior system programmable videogame cartridges more than it does the other computer football programs. That's not a knock,

either. *Cypher Bowl* provides a pleasing balance of hardcore strategizing and arcade-style action. Although it will take the average gamer a little longer to learn its procedures than it does to understand the typical shoot-'em-up, the time a rank beginner will have to invest seems reasonable in view of the pay-off.

This head-to-head contest employs a play-calling system that is both innovative and surprisingly simple. There are four basic offensive formations and the same num-

ber for the defense. Four plays (or defensive coverages) can be ordered from each formation, yielding a total of 16 play patterns for each platoon. That's a total of 256 possible different combinations, so you won't have to run the same play sixty times a game.

Like Atari, *VCS Football*, *Cypher-Bowl* has the teams surging back and forth between the top and bottom of the screen, rather than the more famil-

iar left and right. The playfield scrolls, however, so there isn't any shortage of room to execute that game-breaking fly-pass.

### SSI'S COMPUTER QUARTERBACK

There's more than one way to score a touchdown. *Computer Quarterback* rates low in the area of graphics, and doesn't score much higher with regard to on-screen action, but this Apple II program

is outstanding nonetheless.

The big difference is in the emphasis. Most football games cast the human participants as combination coach/quarterback/safety, with the responsibility of formulating a plan and then carrying it out on the gridiron. *Computer Quarterback* concentrates on giving the gamer a taste of what it's like to be the general manager and coach without sending him into the trenches as an athlete.

Although the game is playable without this option, the

chance to draft a team that's tailored to the gm/coach's personal Football philosophy is *Computer Quarterback's* most exciting feature. All the on-screen gridders aren't created equal, so a coach who wants a "bombs away" pas-



ATARI 5200 FOOTBALL

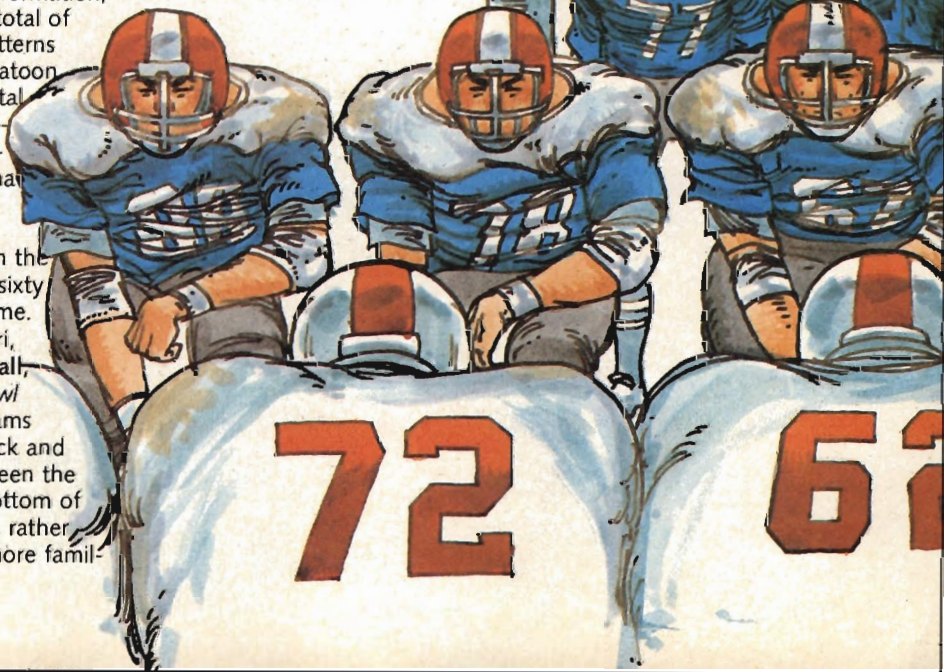



coach must guide his team across the goal line in four plays or cough up the ball to the other side. The number of offensive and defensive options is also more limited, but not quite as much as those

unfamiliar with Football! might fear.

On the plus side, both coaches can set formations before each play,

sing game had better spend the initial allotment of cash on a good quarterback, some receivers and, possibly, a line strong enough to afford the passer enough time to set up for a heave.

Strategic Simulations is adding even more spice to its program by making available an extra disk that includes all the current NFL teams. This

## TUESDAY MORNING QUARTERBACK

Automated Simulation's football program has some features in common with Computer Quarterback, such as its use of NFL teams, but it

has somewhat more to offer in the way of visuals. For instance, you'll need those arcade-trained reflexes to kick a field goal. It makes playing Tuesday Morning Quarterback a whole lot of fun!



# STAND-ALONE SCRIMMAGING

## There's Plenty of Strategy and Action!

### A LITTLE HISTORY

Some people don't give tabletop and hand-held football games much respect. Ac-

tually, that's not so surprising. This negative opinion, found mainly among those who've not had much contact with stand-alones in the last year or so, undoubtedly arose due to the fact that many fly-by-night manufacturers rushed to market with substandard

mini-gridiron devices. They were hoping, obviously, to cash in on the boomlet in stand-alones that occurred during 1980, but many of the games were so crude and simplistic that they just clogged up store shelves.

More recent introductions have benefited from great improvements in technology. Though most are still not quite up to the best designs in the videogame and microcomputer fields, they offer gamers a heap of action in a small package.

### WORLD CHAMPIONSHIP FOOTBALL

Representative of the best in hand-held games is Mattel's World Championship Football. Although the rules of the sport are presented in somewhat distorted fashion—the

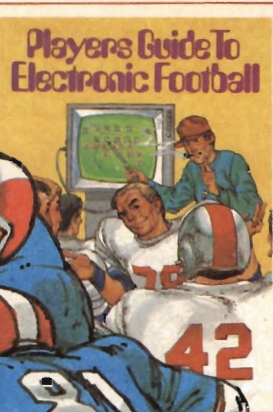
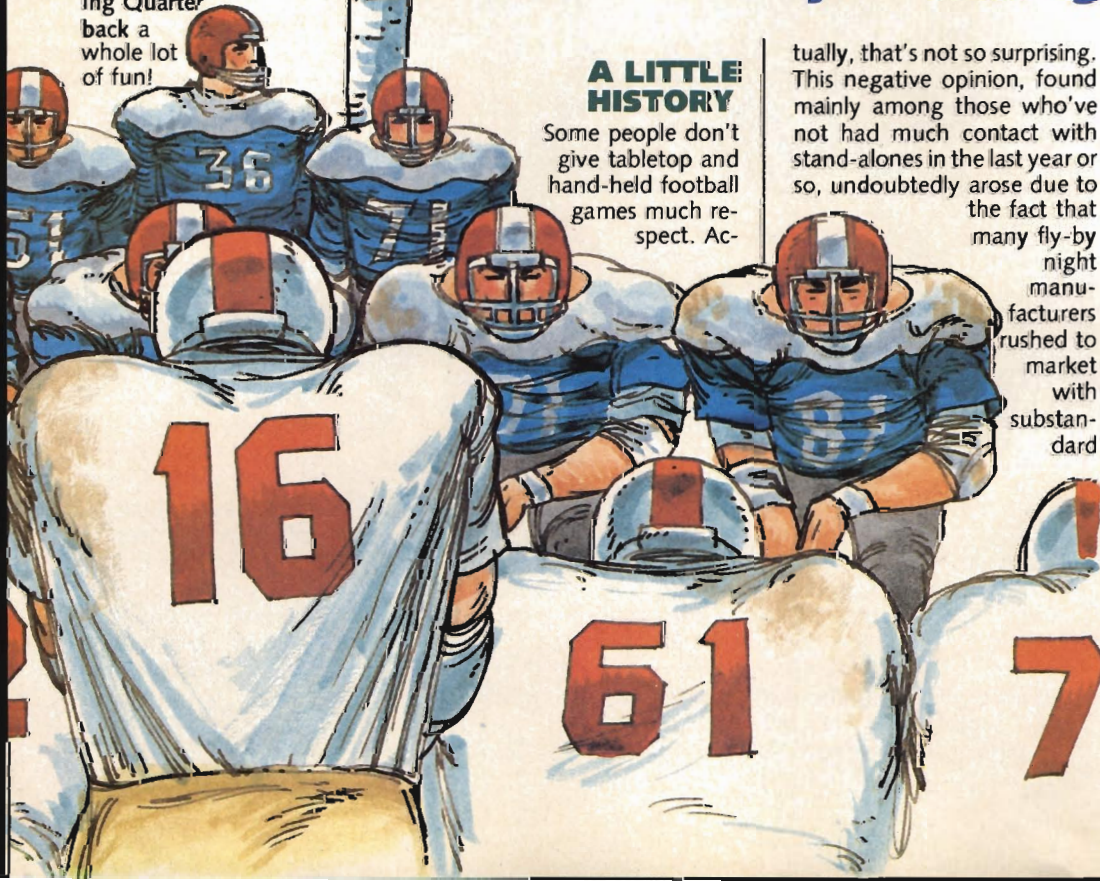



offensive has a variety of offensive and defensive options. And thanks to a decent job of matrixing, the movement of the humanoid-shaped footballers on the field is fairly decent.

The game makes provision for five different offensive formations, from which a range of running and passing places can be initiated. An extra dimension is added to the passing phase by providing an easy-to-use means of programming every twist and turn of the pass route in advance. It may take just a little

longer than just punching in a pre-set pattern, but it certainly does add a real-life feel to this contest.

*World Championship Football* is currently the best pigskin hand-held game we've tested at EG. It ought to be great for whiling away the time between quarters at the real thing this fall and winter.

### SELECT★A★GAME FOOTBALL

The playfield for this stand-alone cartridge shows a 10-yard segment of the field, but it provides the required

breathing room by scrolling between the goal lines as necessary. Coaches can attempt a variety of passing, running and kicking moves, and there is at least some defensive phase to keep the opposing coach interested when his team doesn't have the ball.

Those who can't always find a suitable foe will be glad to know that **Select★A★Game Football** can now be played solo.

### TOTAL CONTROL 4

Although this cartridge

game can't compare with the deluxe videogames, it includes one feature that will make it a highly desirable purchase for some gamers: It can be played by one to four people. Of course, they'll have to crowd around the rather small unit to get a couple of fingers on their control sticks, but at least it's better than waiting for a turn to play. And when there are four rabid football fanatics moving those mini-joysticks around at the same time, there's a lot of life in this little game.

# HOW TO BEAT THE GRIDIRON GAMES

## WINNING FOOTBALL FOR NON-FANS

If you follow football in the real world, you've probably got a pretty accurate idea of what strategies are most likely to work on the electronic gameboard. Many arcaders are not really gung ho pigskin partisans, however, and may need a little help to avoid coming out on the short end of a lopsided score in games against students of the grid game.

**1. Practice.** This is especially necessary for arcade-style action games. Even the best strategy is no good if you can't pull it off successfully under game conditions. The most important thing to rehearse is passing. This takes more coordination and timing than any other aspect of these video football contests and is, consequently, the toughest aspect of play to master.

**2. Mix up your plays.** Even if a play works once, it doesn't necessarily follow that it will work a second time in a row. The naive football gamer should avoid falling into a predictable pattern of signal-calling, especially early in the game. If your opponent

knows you always throw long on third down, he'll be running those intercepted passes back for touchdowns every couple of minutes.

**3. Play conservative defense.** Blitzing the quarterback for a big loss sure boosts the old ego, but it rarely works. If the

ball and the goal line you're defending.

Armed with these hints, even someone who doesn't know a field goal from a flanker back can usually prevent the other gamer from winning a humiliating slaughter.



coach attempting such a rash maneuver is inexperienced, change that to "practically never". The idea is to try to hurry the offense into doing something before it is entirely set up to execute—and then drop back to keep your defenders between the man with

## THINGS TO COME

No fewer than four home video football games will be reaching stores in time to enjoy during the current pigskin season. A quick rundown:

**Computer Football Strat-**

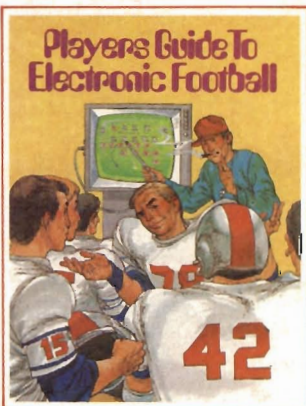

**egy** from Avalon Hill is exactly what it sounds like - an intensive strategy contest based on the same company's much-lauded boardgame.

**Head-to-Head Football** by Coleco is as yet unpreviewed. Intended for play on the new ColecoVision programmable videogame system, it is expected to boast superior graphics and a fairly detailed play-calling scheme.

Atari's **Football** for its new 5200 system gives the company a good shot at making people forget its less than fabulous VCS cartridge. Excellent graphics and smooth play are just some of its highlights.

**Arcade Plus Football** is an upcoming release from the computer software publisher that previously produced **Ghost Hunter**. It's for the Atari 400 and 800 computer systems and stresses on-the-field play-action.



Deluxe editions of fabulously successful games were once the greatest of rarities. **Space Invaders** and **Asteroids** were virtually the only coin-ops to get the sequels in spruced-up models produced right through 1980. Now, with the absolutely awesome success of **Pac-Man** (whose gobbling superstar is the subject of everything from records to Saturday morning TV shows), several games have been souped with additional graphics, audio and/or play mechanics. Why kill the goose who used to lay golden eggs just because she's getting tired? Take one of the offspring and give it a shot at stardom? After all, you may have an entire brood of geese capable of such impressive egg-laying.

Atari has already produced what amounts to three versions of **Asteroids**. In addition to the original and Deluxe models, the visually breathtaking **Quadrascan**, **Space Duel**, utilizes the same play pattern with three-dimensional geometric shapes taking the place of the flat-looking space rocks.

And speaking of family resemblance, who of those skillful gamers in our audience have reached the scenario in **Ms. Pac-Man** when she and her hungry hubby are delivered, by stork, a bawling and naturally, *hungry* little Pac-Baby. Watch for this tiny trencherman in future arcade games.

Why, the gobbler and goblins are even a vital element in Midway's excellent **Kickman**! But the big difference



## Son of Berzerk Meets King Tut!

By BILL KUNKEL

between videogame sequels and, for example, film follow-ups, is that the later games are almost always better, simply because the programmers are constantly learning new tricks. They also try to remove any imperfections

they see in the original. (You know these perfectionist artists, they're never satisfied—and don't we arcaders just love it!).

We've got two games for review this issue from smaller companies, Konami and Kerstien, in addition to the previously-discussed top-hat-and-tails version of a long-standing classic from the friendly folks at Stern.

### FRENZY

*Midway Manufacturing*

Much as I hate cliches, here it comes anyway: If you liked **Berzerk**, you'll love **Frenzy**. I realize this sounds like hype, but it's the goods. Imagine the Standard *Berzerk* maze-playfield, on which the human player's on-screen surrogate begins each round by materializing in a tangle of rooms, exits and entrances, with deadly killer robots positioned randomly across the screen. The object is to use one joystick to manipulate the on-screen player around corners and such, always ready to either zap any robots and escape to the next—and even more hazardous—robot-filled floorplan.

Evil Otto is back, along with a smiling Otto-ette, to dog your footsteps throughout the contest. The big difference lies in the construction of the walls surrounding the combatants. In the original, all the walls were solid. Here, there are two types of dividers. There are titanium steel walls—hardest substance in the world according to Marvel Comics. These walls, are so well armored that a shot will ricochet

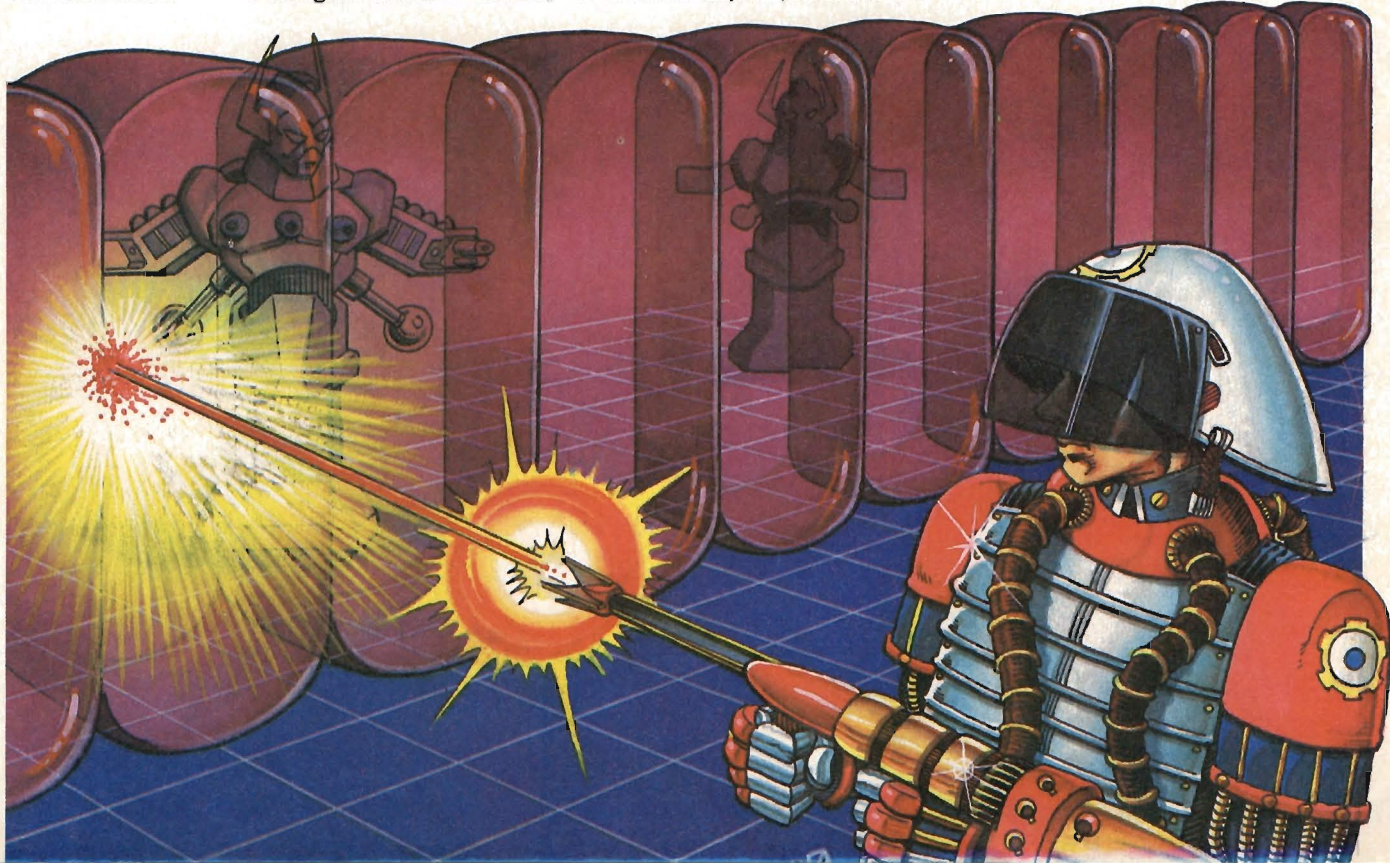



THE WORLD WE KNOW HAS SPAWNED ANOTHER WORLD.  
A PARALLEL WORLD OF ENERGY AND LIGHT,  
A WORLD WHERE VIDEO GAME BATTLES ARE REAL.

# TRON

© MCMLXXXII Walt Disney Productions

ENTER THE WORLD OF TRON, THE VIDEO GAME FROM  
BALLY/MIDWAY, BASED ON THE FUTURISTIC ADVENTURE  
MOTION PICTURE FROM WALT DISNEY PRODUCTIONS.

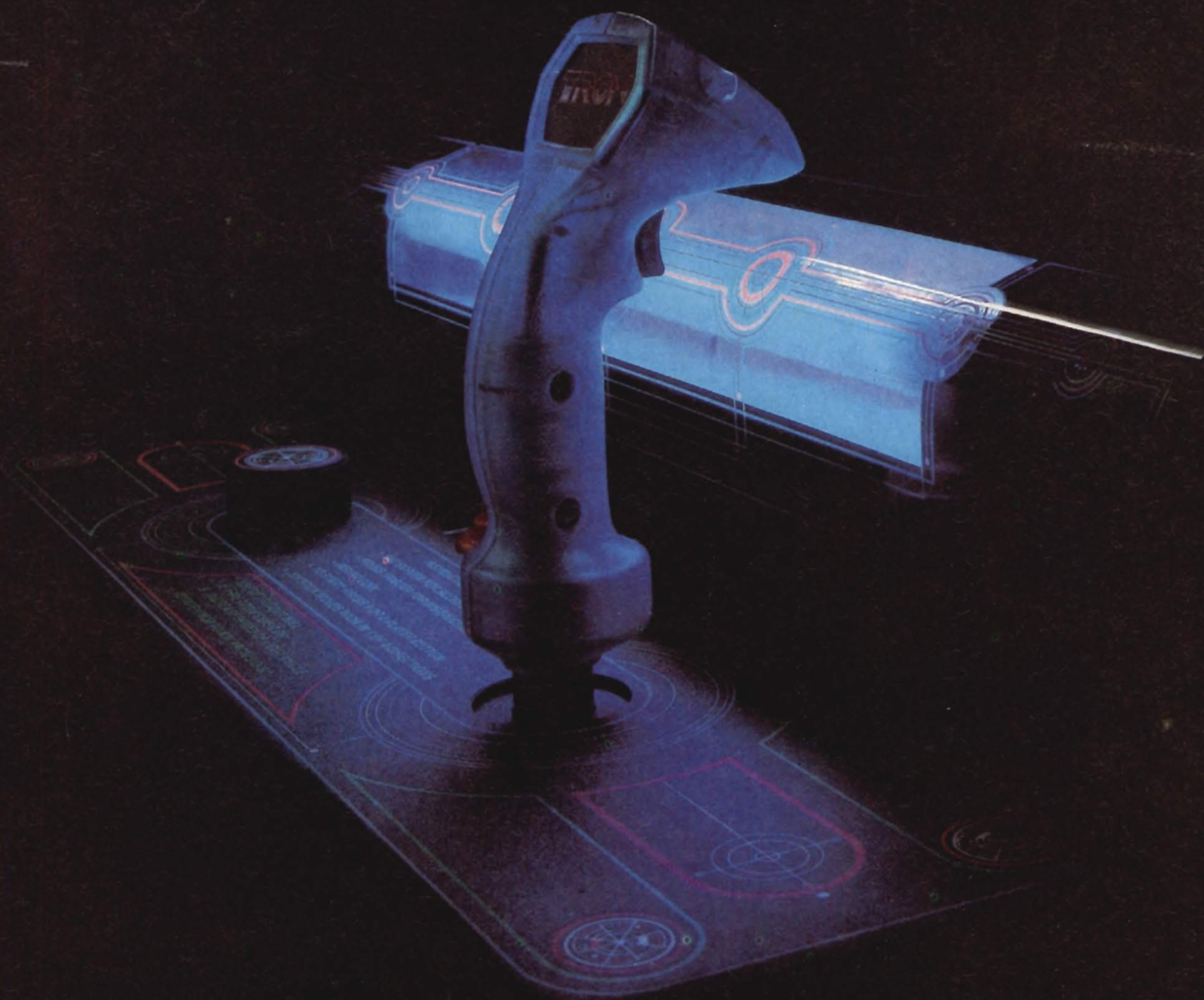

*Bally* | MIDWAY™



right off and catch the hapless gunner should he or she move in the wrong direction. The second type presents far more intriguing strategic and play potential.

These secondary walls consist of tiny balloon-like globes, which can be obliterated with a single laser blast, putting the player in the position to wipe out any robots lined up behind that wall. Of course, it's also not such a bad idea to forget that any angle the arcader can line up to skrag a robot, can be utilized by the robot for returning fire. In other words, ace, even if you've got a clear diagonal aim at your target through a pair of breached walls, don't take too long to shoot or your quarry will simply take you out from the reverse angle.

Don't spend any time dawdling in the maze, as once one of the Evil Otto faces turns up, bouncing across the playfield, he or she (or it?!) are formidable adversaries. Move it, or lose it.

Players still must go around walls. Walking into one is instantaneous extermination—of course, Otto and his back-up singers will move through titanium walls as easily as if they were paper, and he does pick up speed.

At the point where you feel Otto may be ready to make his grand entrance, move the on-screen gunman next to an exit. From that position, take out all robots you can cleanly target. Nothing more frustrating than getting right next to an exit and ting hit by with one of the robot stun guns.

*Frenzy* passes all the requirements for a good follow-up arcade machine.

## RIVER PATROL

Kersten

*River Patrol* is one of the most off-beat arcade games ever to turn up in this field. The screen consists of a bird's eye view of an "African Queen"-type tug steaming down a tropical jungle



the air. Passing the ship over the floaters accumulates points, and, as the journey continues, the tug gathers more and more of the rescued.

The river itself becomes more difficult to navigate as the game progresses. Tighter squeezes and sharper turns make quick wits absolutely essential.

*River Patrol* is not likely to become the next **Pac-Man**, but it's a rather amusing, if slightly humdrum, simulation of a unique adventure-type experience. The graphics are clear and very sharp, and the scenery changes regularly. The biggest problem is pinpoint navigation.

It isn't easy to snake though a couple of rocks about six feet apart or make quick turns away from dangerous beasties without running ashore or into a crash-inducing obstacle.

Definitely worth a few tokens, after

which, let your own taste dictate further play.

## TUTANKHAM

Konami

There's no doubt now about what type of arcade contest manufacturers are putting all their chips on right now—the maze exploration game. Centuri's **The Pit**, the Atari/Namco **Dig Dug**, and now this interesting number have all made their debut within such a short period of time that arcaders may soon find themselves working in the mines as often as they gobble dots or soar the sky in search of alien no good-niks.

This Konami contest puts the gamer in the role of a treasure hunter. Actually, that's an extremely euphemistic term to use for someone who is essentially a grave robber, but it's all fun and games, right? The treasure seeker must explore the highly complex pyramid of a dead Pharaoh, with trap

river. There are rocks to be avoided, as well as crocodiles and other deadly river denizens.

The object is to rescue the drowning people who periodically turn up on the playfield, flailing their arms madly in



RIVER PATROL PLAYFIELD



**NEW**

## Kits Now Available

### NEWPORT "Pro-Sticks"

the Mercedes of Joysticks  
*'Creative Computing Magazine' Aug. 1982*

### Soft-Touch Controllers

for busy fingers and fast action

**NEW** Extension "Y" Adapters  
with rapid fire action

Build your own custom video-game controls from our proven high quality arcade components.

Create your own control console right in your home. Send \$3.00 for a brochure of creative and innovative ideas in custom video game joysticks and controllers. Includes easy to follow schematics and instructions for Atari, Apple, Pet Commodor, TSR-80, and other computers, and a complete kit and components price list.

INQUIRE ABOUT OUR CLUB DISCOUNTS

Please rush me \_\_\_\_\_ brochures at \$3.00 each (includes First Class Mail and handling) and mail to:

Name \_\_\_\_\_

Address \_\_\_\_\_

City \_\_\_\_\_ State \_\_\_\_\_ Zip \_\_\_\_\_

### NEWPORT MACHINE DESIGN

P. O. Box 418, Bishop, CA 93514  
(714) 873-5677



TUTENKHAM  
PLAYFIELD



doors and a multitude of dangers to keep players on their toes.

The explorer is searching, specifically, for keys which open special doors within the labyrinth and the treasures which are scattered randomly about. The player is armed with a laser pistol (?!) which fires horizontally, but not vertically; a "Flash Bomber", which destroys all on-screen enemies but can only be called upon once per rack.

As play opens, a clock ticks away the precious seconds remaining in the soldier of fortune's efforts to clear a particular level. Using a clever parlay of offensive might (opening up with that

laser cannon the on-screen surrogate totes around) and an awareness of the various "warp zones" which dot the playfield, most arcaders should find the early levels quite plunderable. "Warp Zones" are areas where the explorer can sort of "bean out" to another, randomly selected locale. As with all escape hatches of this type, there is always the danger that the spot to which the warp power delivers your explorer, will be even less pleasant than the situation from which he escaped. As always with these tactics, call upon them only when it is a clear-cut case of warp or die.

The exotic setting, the eye-pleasing graphics and the perfectly complimentary audio, compliment this highly unusual crossbreed of several popular arcade games. The element of search, treasure and general exploration is a hallmark of the fantasy quest contest, while the playfield's walled construction creates a literal maze through which animated characters creep, run or blow up other creatures. The "Flash Bomber" is essentially the "Super Zapper" from *Tempest* taken to the sands of ancient Egypt (but why a laser gun??). Still, this one could be a real sleeper, developing slowly and building an audience. There's a lot to see, and the entire production is choreographed with skill and care, right down to the now-commonplace radar map located atop the playfield.

For a game with a different look and lots of familiar play elements, this is as good as they come. Way to go, Konami!

Ah, I can see by the dots on my *Pac-Man* watch that we've come to the end of the road for this installment of "Insert Coin Here". Next issue, we'll be taking a look at the coin-op version of the first major motion picture based on computers and videogames, Midway's *Tron*.

Be there or be square. Aloha.



## Learn To Repair Video Games!

It's no secret . . .

Video games seem to be everywhere! The extraordinary popularity of coin-operated video games has created an enormous demand. Not only for the games themselves, but for qualified service personnel as well.

**Randy Fromm's Arcade Schools** are a practical, no-nonsense look at how video games work, and how to repair them when they don't. *No previous knowledge of electronics or video games is required* to get the most out of the six day course. Lab sessions allow students to gain valuable "hands-on" experience. Late model video games are used during lab and lecture so Arcade School graduates will be familiar with the types of equipment they will encounter on the job. The tuition of \$400.00 includes all texts and classroom materials. There are no hidden costs.

Founded in 1980, Randy Fromm's Arcade Schools are the most respected and often recommended training programs in the coin amusement industry. As a technical writer, Randy Fromm's comprehensive articles appear regularly in the industry trade journals. Now he has condensed his ten years of experience into a proven Arcade School program that has allowed hundreds of Arcade School graduates learn the easiest, fastest, and most accurate ways to repair coin operated video games.



### Attend the Arcade School nearest you in:

Atlanta, GA  
Baltimore, MD  
Chicago, IL  
Dallas, TX  
Minneapolis, MN  
New Orleans, LA  
Phoenix, AZ  
Salt Lake City, UT  
San Francisco, CA  
Toronto, Ontario  
Whichita, KS

Call or write for  
FREE information package

### Randy Fromm's Arcade School

6123 El Cajon Blvd.  
San Diego, CA 92115  
(714) 286-0172



## Inside the Videogame

by LES PAUL ROBLEY

**M**ost of today's achievements in the realm of special effects, like most things in the world of filmmaking, are usually a copy of something previously done. It's hard to find completely new and untrod territory. After all, there are only a certain number of ways to produce any given

## Movie's Special Effects

special effect in a movie (i.e., blue screen, front screen, miniatures and so forth).

Disney's **Tron** is a notable exception. It is totally unique in idea as well as actual design. The special effects which the studio magicians used to create the movie's universe owe nothing to the standard techniques mentioned previously. The appearance of

THE  
MAGNIFICENT  
LOOK OF...

TRON



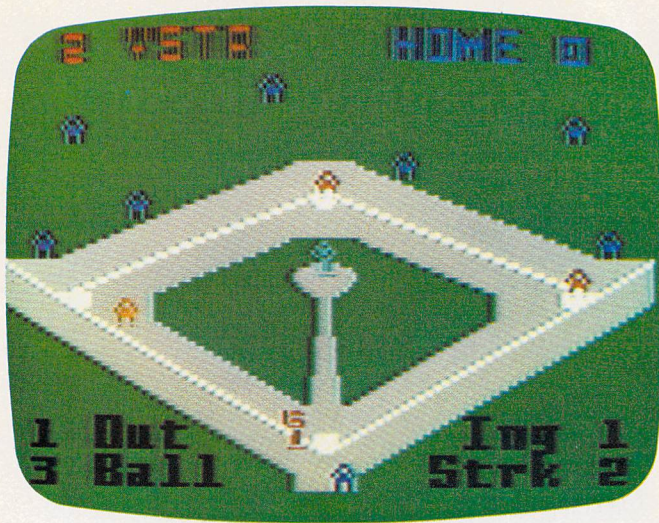

88% Preferred Intellivision®

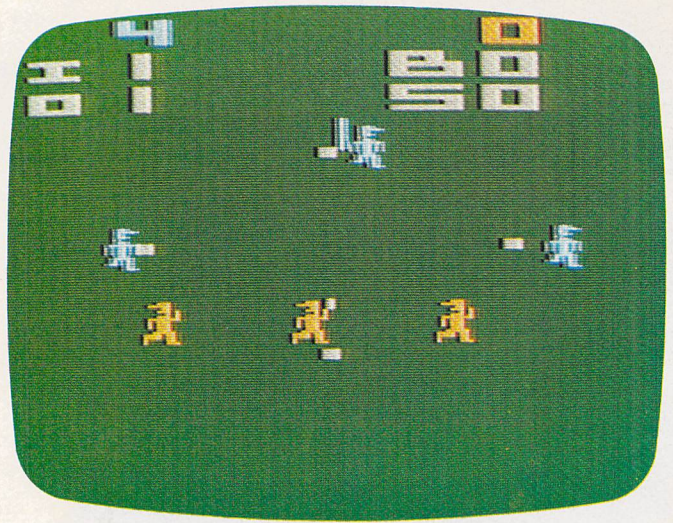

2% Preferred Atari®

**APPARENTLY,  
GEORGE PLIMPTON  
ISN'T THE ONLY  
ONE WHO CAN SEE  
THE DIFFERENCE.**

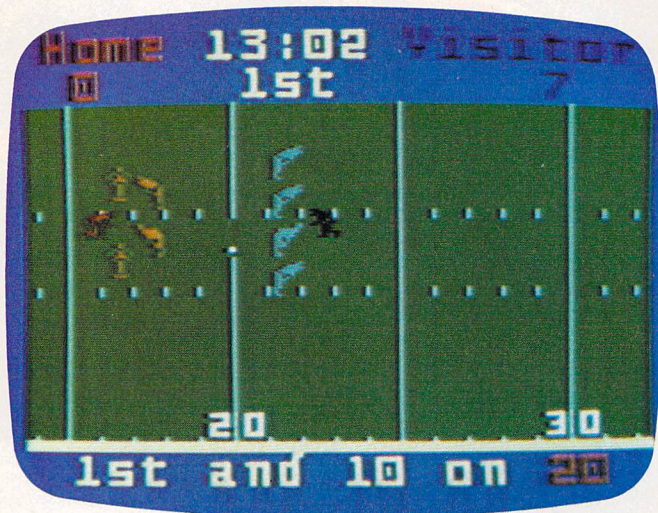

75% Preferred Intellivision.

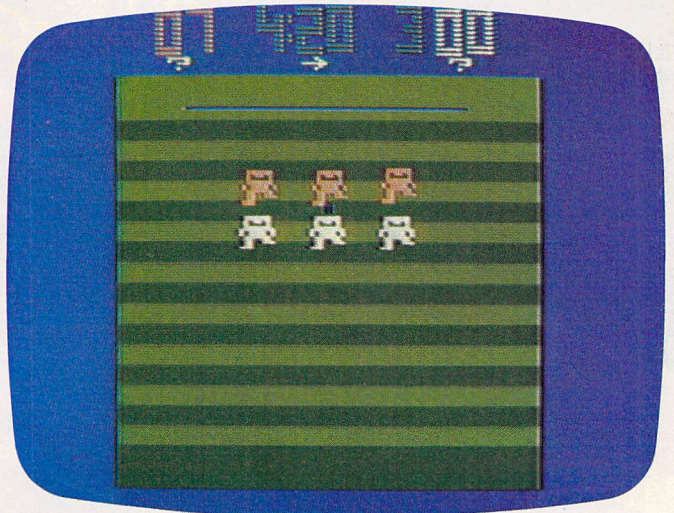

2% Preferred Atari.



Mr. Plimpton, bless him, has been quick to point out to TV viewers just how wonderful Intellivision® graphics and gameplay are.

But who better than baseball and football fans to compare Atari® sports games with ours?

As you can see from the independent research figures shown,\*\* baseball and football fans were well and truly on our side.

It just goes to prove what we've said all along.

Intellivision NFL\* Football and Major League\* Baseball are the closest thing to the real thing.

While we're on the subject of the real thing, we'd like to tell you about an exciting new addition that will make playing your Intellivision even more lifelike:

Lifelike voices. Provided by the new IntelliVoice™ module.

IntelliVoice, sold separately, adds a whole new dimension of reality to our games and will be available later in the year.

But IntelliVoice is just one of many reasons to buy Intellivision.

Already we offer a better designed system with greater attention to detail.

Our lifelike players make our sports games more realistic than Atari.

Or as *Buying and Beating the Home Video Games* author Ken Uston says, "Intellivision graphics are unsurpassed."

Our sophistication makes the games more challenging.

*Radio Electronics Magazine* echoes this: "Intellivision has placed more emphasis on strategy and realism than any other game system."

Our hand controller has 16 positions, so you're able to maneuver players and objects in more directions with greater precision and accuracy than with the Atari controller.

Our library of cartridges is growing fast, as is our popularity among video game experts.

With special introductions to come, like Tron: Deadly Discs™ from the Walt Disney movie.

All this attention to detail makes all the difference in the world to people who already own Intellivision.

If you visit your local dealer, you'll see the difference, too.

MATTEL ELECTRONICS®

**INTELLIVISION®**

Intelligent Television

\*Trademark used under license from designated owner. \*\*Based on interviews with 300 baseball and 300 football fans who were shown unbranded sequences from four video games. 10% supported the other two baseball games and 23% supported the other two football games. \*\*\*Tron is a trademark owned by and used under license from Walt Disney Productions.

©Mattel, Inc. 1982. All Rights Reserved

Atari® is a trademark of Atari, Inc.



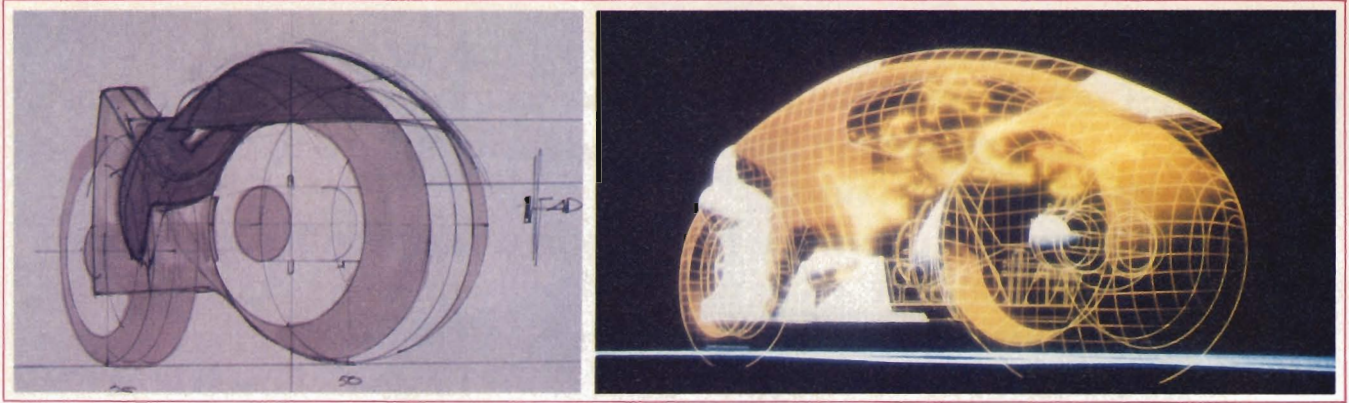

(Left) Original schematic sketch of the "light cycle" used extensively in the computer sequences of "Tron" (Right) The final version as seen on the screen.

*Tron* will eventually cause all existing books on the subject of cinematic special effects to be updated, because the Disney flick doesn't fall easily into any of the traditional categories of special effects.

Special effects R & D depts. are virtually non-existent in film studios today. Not so at Disney. Of the \$6 million devoted to *Tron's* visuals (one-third of the entire budget), as much as 30% was spent on research and development.

"Nearly everything had to be created from scratch," says Harrison Ellenshaw, associate producer and co-supervisor of effects. "We had to be sure that the processors needed to process the large codaliths would be consistent, existing cameras and enlargers had to be modified, even special boxes had to be made to hold the extra wide cells needed to handle the anamorphic format. If *Tron* was to be remade now using this existing equipment, its budget would probably be a third less."

Writer-director Steven Lisberger is largely responsible for the film's incredible look. According to Ellenshaw, Lisberger not only brought the story to Disney, but showed the way to do it. Long a devotee of vidoegames, he originally conceived the project back when *Space Invaders* first hit the market. This was well before anyone thought of electronic gaming as a national pastime. After several disappointments from other studios, he and *Tron* producer Donald Kushner got an enthusiastic reception from the newly appointed vice-president for motion pictures at Disney Studios, Tom Wilhite. A company once known for taking risks when it was still under the creative genius Walt Elias Disney, the studio has, since his death, turned out many formula pictures that were bitter disappointments. Wilhite had the

foresight to recognize the potential of this project and coddle it along. The birth of *Tron* can almost be thought of as a rebirth for the studio.

"They first gave us money to do a demonstration, to prove that we could create the effects we claimed were possible," recalls Lisberger. "It's to Disney's credit that they didn't say, 'Call us when the computer can do a dog.'" From the \$50,000 test came a five minute effects reel, and what followed was special effects' history.

Lisberger's first move was to hire a creative trio of artists to dictate the visual style for *Tron*. Futuristic indus-

trial designer Syd Mead was called in to create the physical settings and vehicles that would later be computer-generated, such as the light cycle, electronic tanks, and solar sailer. French comics artist Moebius, known for his unique contributions to *Heavy Metal* magazine, provided the look for characters which populate the videogame dimension. High-tech commercial artist Peter Lloyd handled the color styling, background design, and drew many of the matte painted backgrounds actually seen in the film.

*Tron's* biggest innovation is the "painting with light" technique used to create the electrified outfits worn by all the characters for two-thirds of the movie. To achieve this 53 minutes of non-stop visual excitement, an assembly line of 80 artists and craftsmen worked for eight months on finely detailed post-production hand matting. Even though the end product looks extremely complicated, the basic method is rather simple to understand.

Refer to the picture of the five separate images of the villain Sark. The first is a black and white picture of David Warner shot during production on a sound stage that was completely covered with black flock paper, cloth, or velvet, depending on the closeness of the taking camera. All of the video warriors in the electronic world were usually shot against black on 65mm black and white film (the 65mm image is preferred over 35mm due to the better resolution and greater copy ratio afforded when the various elements are put together in the later stage of compositing). A few times the actors were photographed in a set that was actually painted in black and white, such as the sequences inside the electronic tanks. For the vehicles in the light cycle chase, Bruce Boxleitner (*Tron*) was mounted atop a black velvet box with handlebars to get him into



In the world of "Tron," Programs who persist in their belief in Users are sentenced to death on the Game Grid. Here a gladiator plays Deadly Disks.



the position needed for the later addition of the cycle.

Once the 65mm image of Sark was processed, each frame of film was placed in an enlarger for blow-ups onto large codalith cels (clear cellulose that's about 10 in. by 24 in. containing a contrasty negative image of Sark). At the bottom, standard three-hole animation punches were used to mount the large cels so that each one would be in perfect registration with the next corresponding frame.

Since there are approximately 53 minutes of electronic world footage in the movie, and film runs 24 frames a second, over 75,000 frames of these codaliths had to be printed. This negative-image codalith of Sark was placed in contact with another codalith of the same size, and a direct reverse, or positive, image was created. That's another 75,000 of large codaliths, for a grand total of 150,000!

After placing clear cel overlays over these codaliths, cel painters meticulously blacked (or matted) out the individual portions of the figure that they did not want to expose for the later camera passes. In the case of the Sark figure, four hold-out mattes were created: one each for the eyes, face, circuits, and body. These were placed over a light box, and a VistaVision camera mounted above made four separate passes, each with the appropriate color filter.

The range of possibilities with this method was limitless. By making separate face and eye reveals, the face could be given a slightly different color from the body, and the eyes could be made to appear more intense. By varying the camera's exposure on the circuit reveal, his lights could be made to correspond with the character's general mood. If he became angry, exposure could be increased and his circuits would appear to flare out.

As is probably evident, at least two hand-painted hold-out mattes must be inked for each frame of film: one for the circuit reveal and one for the body reveal. Since there were 150,000 negative and positive codalith images, this required a minimum of 300,000 hand-painted cels for the electronic world.

More hold-out mattes were often needed—ones for teeth, noses, eyeballs, and any background set elements that needed to be exposed separately. Ellenshaw told *EG* that a typical shot required 12 passes in the VistaVision camera. Some more com-

plex sequences, as in the interior of the electronic tank, needed as many as 50 passes. The eighty effects crew members must have had their hands full painting mattes for each of these separate passes!

The final composite of Sark as he appears against the blue triangular background is seen in the bottom picture. The circuit reveal matte and the reverse body reveal matte described above also allowed the crew to place the figure of Sark into any desired environment. He could be composited into a computer-generated background, or into a matte-painted background as he's pictured here.

Ellenshaw reveals that some 300 matte paintings, versus 150 computer-generated backgrounds, were created for *Tron*. A typical one was drawn in an extremely dull manner, all in gradations of black or white. The painting was photographed onto a large piece of Ektachrome film and then color was added by gelatin filters in much the same way as the figure codaliths. By painting the background in such low contrast tones, subtle color variations were possible as is typical of computer imaging. With this method, Ellenshaw believes that the viewer won't be able to tell when the computer-generated backgrounds end and the hand painted ones begin.

The main thing that can be said for this backlit color compositing technique is the first-generation look it bestows on the visuals. Whenever color film is duplicated, it suffers resolution loss, becomes grainy, and loses richness of colors. Disney's technicians have achieved a finer grain image by shooting on 65mm black and white stock, and haven't suffered any color losses since the color was added in the artwork duplication stage. Any fades and dissolves were also accomplished at this time to avoid having to go to

another generation.

The only film which made any new headway using a similar method was a 1968 short called *Omega* by Donald Fox. Fox photographed many of his figures in black and white and added separate color passes later to create a strikingly surreal end-of-the-world vision. Disney's *Tron* was able to take this imaginative, yet academic, attempt and create an entire electronic civilization in which energy appears to actually live and breathe.

A videogamer's fantasy made real—on the screen.

*Tron* looks to be the most successful

An early production sketch depicting one of Sark's merciless guards, complete with shock pole.

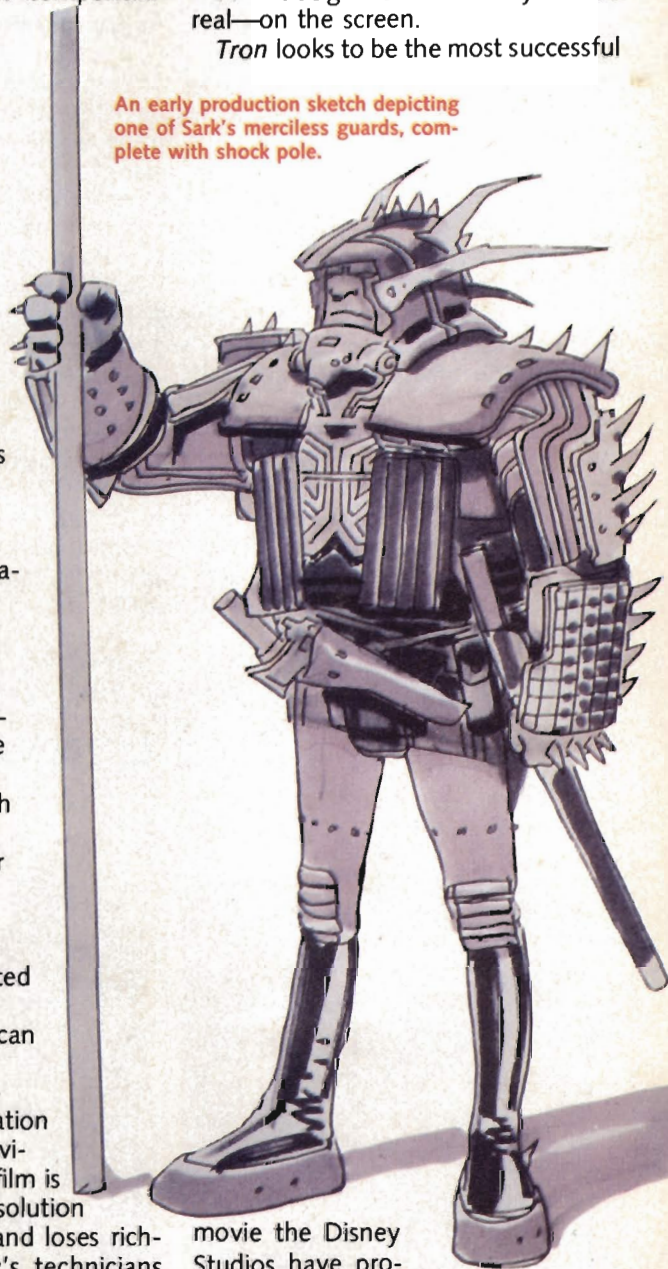

movie the Disney Studios have produced since *Sleeping Beauty*. The primary source of its popularity, it appears, is the uncanny way in which the special effects wizards have taken every dyed-in-the-wool videogamer's arcade fantasies and made them burst into life on the screen.





# VIDEOGAME

## Readers Enshrine Two Great Games

By THE EDITORS OF ELECTRONIC GAMES

The voice of the electorate has spoken. Several months ago, **Electronic Games** announced the establishment of a unique institution, the Videogame Hall of Fame. The idea is to provide a continuing and enduring method for honoring the all-time best electronic games, whether they've gained acclaim in the coin-op or home arcade segments of the hobby.

To get the ball rolling, we polled the members of the **EG** editorial staff. The consensus picked six games as charter members of the Videogame Hall of Fame: **Pong** (Atari), **Space Invaders** (Taito), **Asteroids** (Atari), **Pac-Man** (Namco/Midway), **Quest for the Rings** (Odyssey) and **Major League Baseball** (Mattel). Few would seriously question the impeccable credentials these half-dozen titles possess.

Satisfied that our project was getting off to a strong start, we threw the question of which other titles should be honored into the laps of a group of people with an outstanding grasp of the videogame scene—our readers. The response to our call for nominations couldn't have been more heartening, either in quality or quantity. Well over 200 ballots reached our New York City office before the deadline.

Of course, there can only be very few winners out of a field of so many good games. Although there was the

expected diversity of opinion—there are nearly as many favorite games as there are gamers—a handful of titles emerged as significantly more popular and respected than the rest.

By order of the gaming public, two titles are entering the Hall of Fame effective this month. Heading the list of coin-op games is **Defender** (Williams), while the pick of the home videogames this time proved to be **Star Raiders** (Atari). (You'll find our analyses of both on the page facing.)

The list of games which almost, but not quite, made the Videogame Hall of Fame is nearly as interesting as knowing which ones actually got into it. Both **Tempest** (Atari) and **Donkey Kong** (Nintendo) came within a few votes each of surpassing *Defender's* total vote. Other coin-ops showing strong support were (in order of placing): **Centipede**, **Ms. Pac-Man**, **Missile Command** and **Gorf**.

*Star Raiders* out-pointed other home videogames by a wide margin, but numerous other programs got significant amounts of support, too. The runner-up to *Star Raiders* were (again, in order of placing): **K.C. Munchkin** (Odyssey), **Demon Attack** (Imagic) and **Astrosmash** (Mattel). Since these are all relatively recent productions, it will be interesting to see whether they gain popularity or fade in next year's Videogame Hall of Fame election.

## HALL OF FAME RUNNERS-UP MAYBE NEXT JUNE





# HALL OF FAME

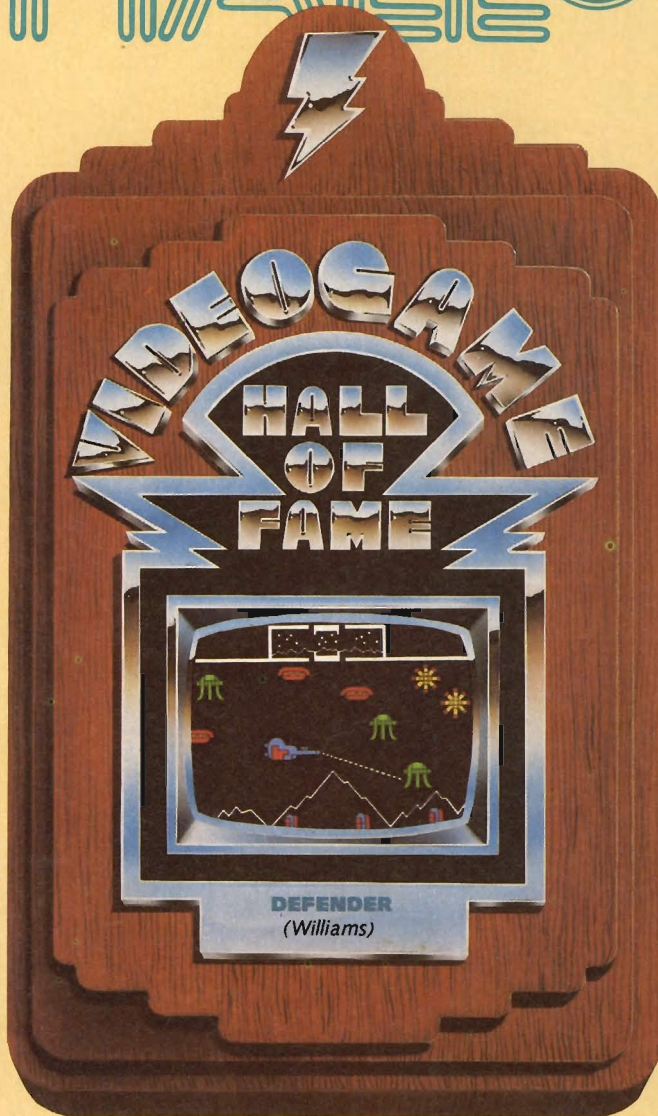

## Defender (Williams)

When some future historian compiles a list of the really important videogames, look for **Defender** to appear in a place of honor at or near the top of the roll. With the exception of **Pac-Man**, no game has exerted a stronger effect on commercial amusement centers over such a long period of time.

The reason is crystal clear to anyone who has ever staked a quarter on this machine. *Defender* features the type of thrill-a-minute action that had made the scrolling shoot-out—the genre it pioneered so successfully—one of the most popular play-formats ever incorporated into an electronic game.

*Defender* is markedly different from the games which preceded it on the coin-op sales chart. Rather than repeating the same action over and over, this game is a mini-adventure with the clearly defined goal of saving the survivors of a planet-wide attack.

And when you've achieved that objective, you know you've really done something. *Defender* is the most difficult of the super-popular coin-ops.

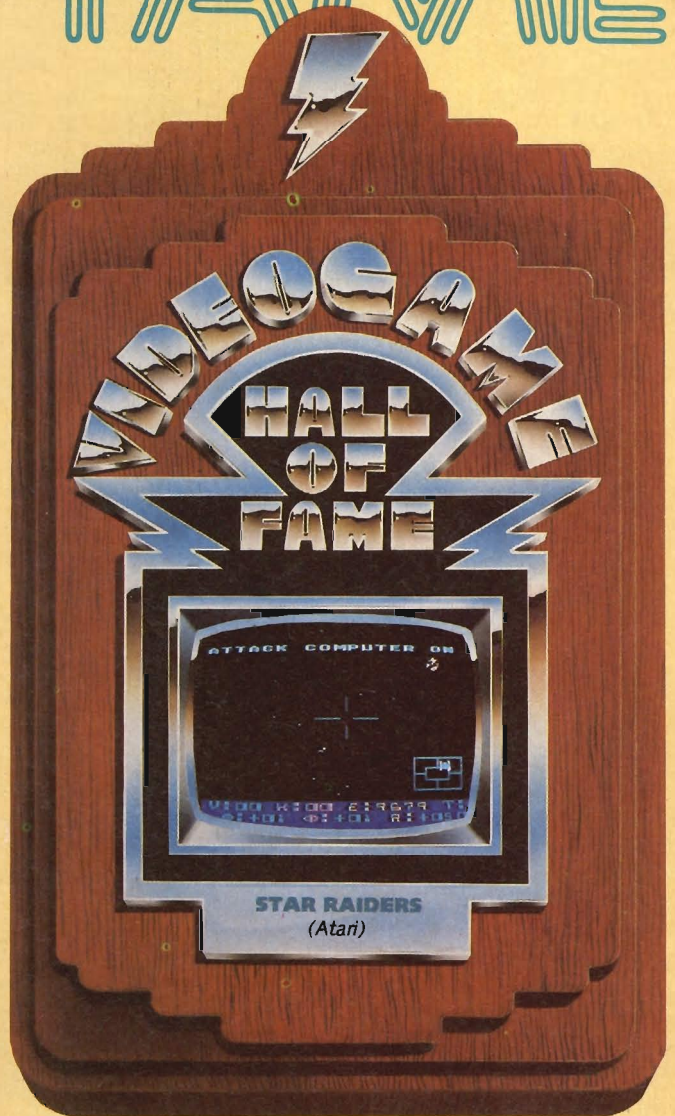

## Star Raiders (Atari)

Everyone talks about the tremendous pace of innovation in the computer field, yet here's a game that has remained virtually as fresh and stimulating as the day Atari shipped its first cartridges to the retail stores. **Star Raiders** is a beautifully executed Trek-type game that immediately made all other programs in the same general classification obsolete.

The first thing everyone notices about this program for the Atari 400/800 computer systems is the riveting visuals. *Star Raiders*, however, is much more than just another pretty face. With its multitude of strategic and tactical options, this science fiction classic can keep several computer-gamers happily flying along the spacelanes for hours on end.

Yet *Star Raiders* is more than "just" a great game. It also has its share of historical importance. Its introduction sent shock waves throughout the electronic gaming world, serving notice that computer programs would no longer take a back seat to programmable cartridges in graphic excellence or action-oriented play.





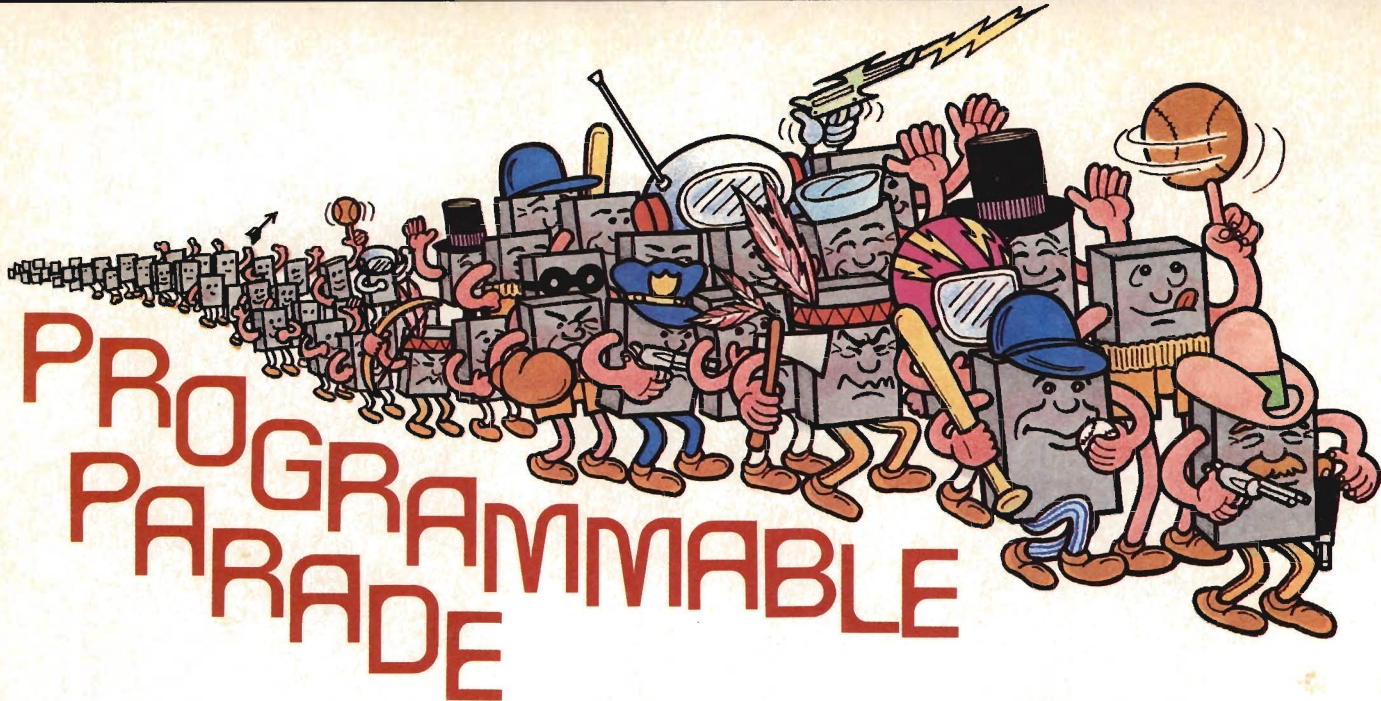

## Face the Terrors of the Alien Cave!

By BILL KUNKEL & ARNIE KATZ

### SPACE CAVERN

Game by Apollo/Atari VCS

You've landed your spaceship on a strange, unexplored planet. After donning your spacesuit and checking the charge on your laser rifle, you leave the craft and start scouting the countryside. Before long, you wander into what turns out to be a huge natural cave with smaller alcoves leading to ominously dark tunnels. Then, in one chilling instant, you discover that you've picked a world which is definitely *not* barren and uninhabited. Flying electrosauri and shaggy marsupods have already staked a claim to this cavern, and these creatures aren't too fond of uninvited guests.

That's the setting for *Space Cavern*, a sequel of sorts to *Space Chase*, which

Games by Apollo published earlier this year. Like the earlier cartridge, this one won't be easy to master, but it ought to provide arcade aces with an enjoyable invasion game that will last through hundreds of replays.

Getting into *Space Cavern* requires a little patience and study. Its control system is different enough from other invasion contests that a period of adjustment is necessary. The gamer controls the space suited figure at the bottom of the screen, moving the crewman left or right by pushing the joystick in the desired direction.

To fire at the electrosauri hovering near the roof of the cave, just push the action button. Unlike the flying fiends, the Marsupods rush at the defender from those previously mentioned side-caves. Pushing the stick forward causes the on-screen hero to pivot to the left and fire. Pulling it back makes the spaceman shoot his disrupter to the right. The arcader begins the game with

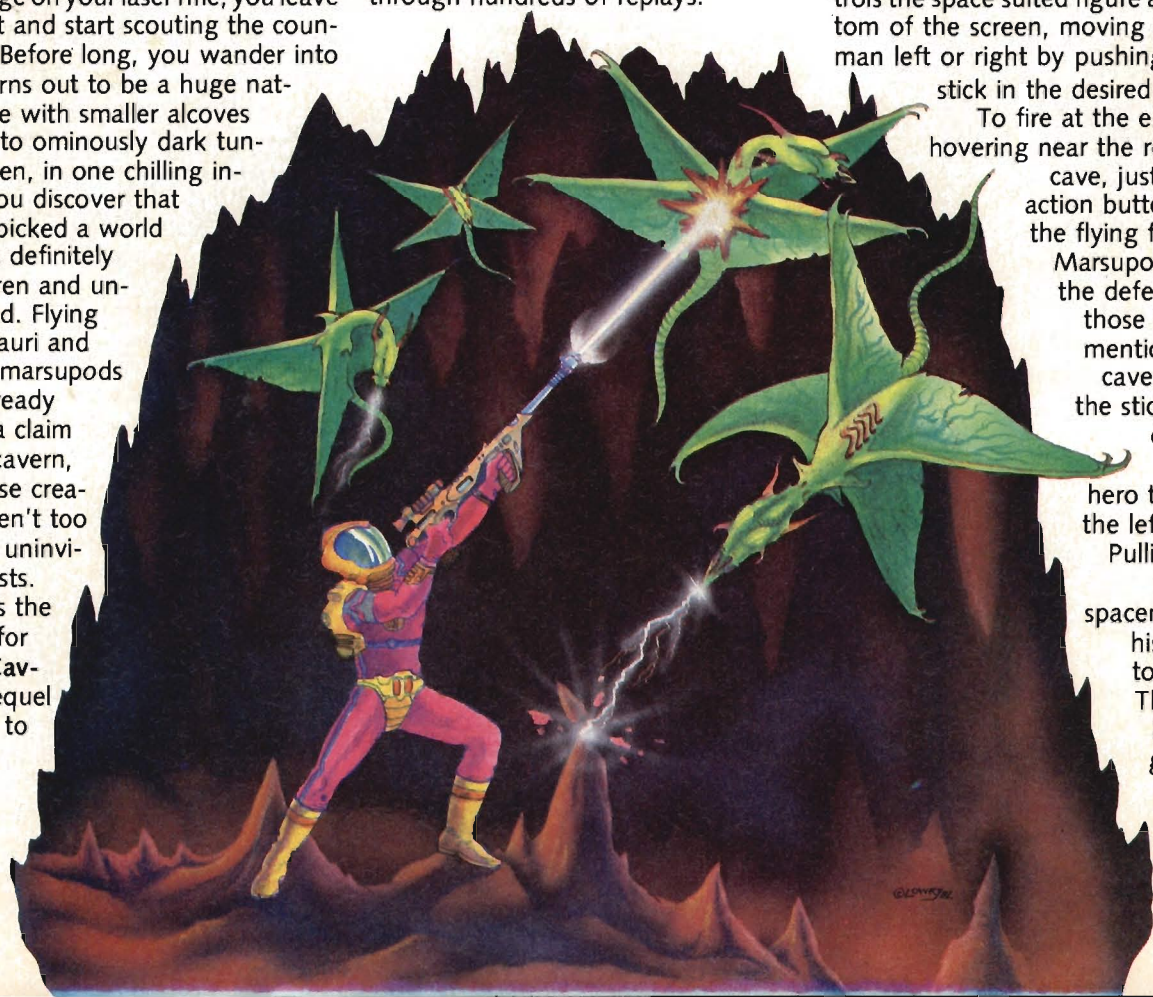



# PLAY BALL OR SPACE INVADERS\* OR MISSILE COMMAND™ OR SUPER BREAKOUT® OR NIGHTDRIVER® OR ASTEROIDS™ OR PAC-MAN†



ATARI MAKES MORE HOME VIDEO GAMES THAN ANYONE.  
**HAVE YOU PLAYED ATARI® TODAY?**



 A Warner Communications Company  
©1982 ATARI, INC.

\* Space Invaders is a trademark of Taito America Corp. †PAC-MAN is a trademark of Midway Manufacturing Co. licensed by Namco America, Inc.



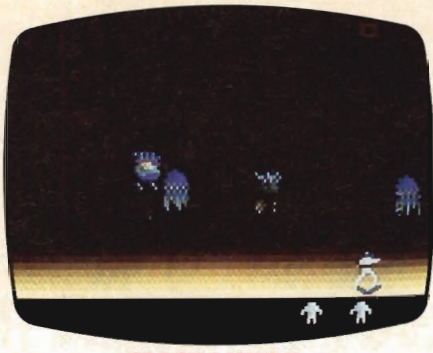

**SPACE CAVERN**

four crewmen, available for action one at a time. A bonus man is earned when the scoreboard shows more than 20,000 points have been scored. There is an unlimited amount of ammunition in the disrupter rifle. That's a lucky thing for the spaceman, since there is no shortage of beasts hoping to fry or decapitate him.

The *Space Cavern* cartridge includes 48 variations. Half of them challenge the gamer with two flying electrosauri, while the rest present an attack group consisting of four of these beasts. The latter should really be reserved for teaching people the game, because the action is much more exciting when there are four creatures weaving back and forth overhead, all of them firing bolts of electricity.

Other options govern whether Marsupods will be rushing at the crewman from the playfield edges, the opportunity to begin play at advanced skill levels and the choice of having the electrosauri fire their blasts straight or in a random direction.

Although the graphics and sounds are quite decent overall, some specific effects are better than others. The best visual sequence occurs when the electrosauri zap a spaceman with one of their blasts. The victim sizzles in a most convincing fashion before turning into a skeleton right inside his suit. On the other hand, the monsters themselves may not be drawn to your taste, especially if you don't like your menaces to look too cartoony.

## **YARS' REVENGE**

Atari/VCS

A combination of familiar play elements and somewhat revolutionary packaging concepts combine to make *Yars' Revenge* a potential blockbuster that misses greatness by an eyelash.

It's a well-known fact that most arcaders simply plow into new games without bothering to read the instructions or supplemental material. The average gamer plays until he or she

gets stuck, tries a dozen different approaches to solving the dilemma and, only then, grudgingly peeks at the game's documentation. All too often, the arcader discovers that those pink creatures he's been blowing to bits are actually allies who are supposed to be rescued, not obliterated.

In *Yars' Revenge* not only the instructions, but the excellent comic book that comes enclosed with the cartridge should definitely be read before playing. Produced in a style reminiscent of *Heavy Metal* magazine, the graphic story recounts the saga of the Yars, peace-loving insectoid creatures who evolved from a few Earth-houseflies after accidentally stowing away on a space mission. The story goes on to tell of a society built by the cosmic bugs and how their serene life-style was abruptly shattered by the coming of the villainous, warlike Qotile. These space bullies kicked the Qotile off the unprepared Yars, who only began constructing a mighty

weapon, dubbed the Zorlon Cannon (after the name of the Yars' home planet), at the last instant. Armed only with a half-built cannon and a supply of energy missiles, the Yars send out their greatest warrior to take revenge on the bloodthirsty Qotile.

The playfield configuration consists of the Qotile, protected by a pair of alternating shield-walls comprised of blockish cells. The initial shield is rectangular and static, but the secondary one is a revolving rectangle. The Yar appears on the left of the screen, just behind the neutral zone, a vari-colored column that extends the height of the playfield. Once within this zone, the Yars' and Qotile weapons—except for the swirls, which will be covered in a moment—are rendered harmless.

The Yar must destroy the Qotile shield, or at least the portion directly in front of the Qotile without being destroyed by either the enemy's destroyer missiles, which move slowly through space but pursue their quarry





with dogged determination, or the truly dangerous swirls. Periodically, the Qotile will transform itself into a whirling disc of death, flinging itself at tremendous velocity toward the Yar. The Yar must, after clearing away sufficient shielding, touch the Qotile in order to summon up the Zorlon Cannon, which will always appear directly parallel to the Yar on the extreme left of the screen. The Yar must then position itself so that when the cannon is fired, the Qotile will be destroyed, and the Yar is long out of the way.

The comic book intro gives this game a strong context, making the human player a character in a science fiction space opera, while the play mechanic, somewhat like **Star Castle**, is easy to learn. Sound is excellent and the graphics are quite acceptable—with little blinking of on-screen objects.

The big question, then, is why the game isn't quite as exciting as it could be. The game has only one objective that must be repeated indefinitely. Today's players have grown used to progressive play, new challenges and changing graphics. In this regard, *Yar* is far too static.

Understand, *Yars' Revenge* is not a bad game by any means, and many gamers are sure to greatly enjoy it, especially at the higher difficulty settings. (Try one of the "Ultimate Yars" options for a real challenge).

## THE EMPIRE STRIKES BACK

Parker Brothers/Atari VCS

Let's face it: Starting with a title like this, it would take a tremendous effort

to end up with anything/less than a top selling videogame. Call it integrity. That, plus intelligence and foresight, was used by Parker Bros. to produce an excellent cartridge. **The Empire Strikes Back** isn't flawless, but the company's first title is a scrolling shoot-out that effectively blends

graphics and sounds inspired by the movie with dynamic on-screen action.

As a good tie-in should be, *Empire* is solidly based on the George Lukas' sci-

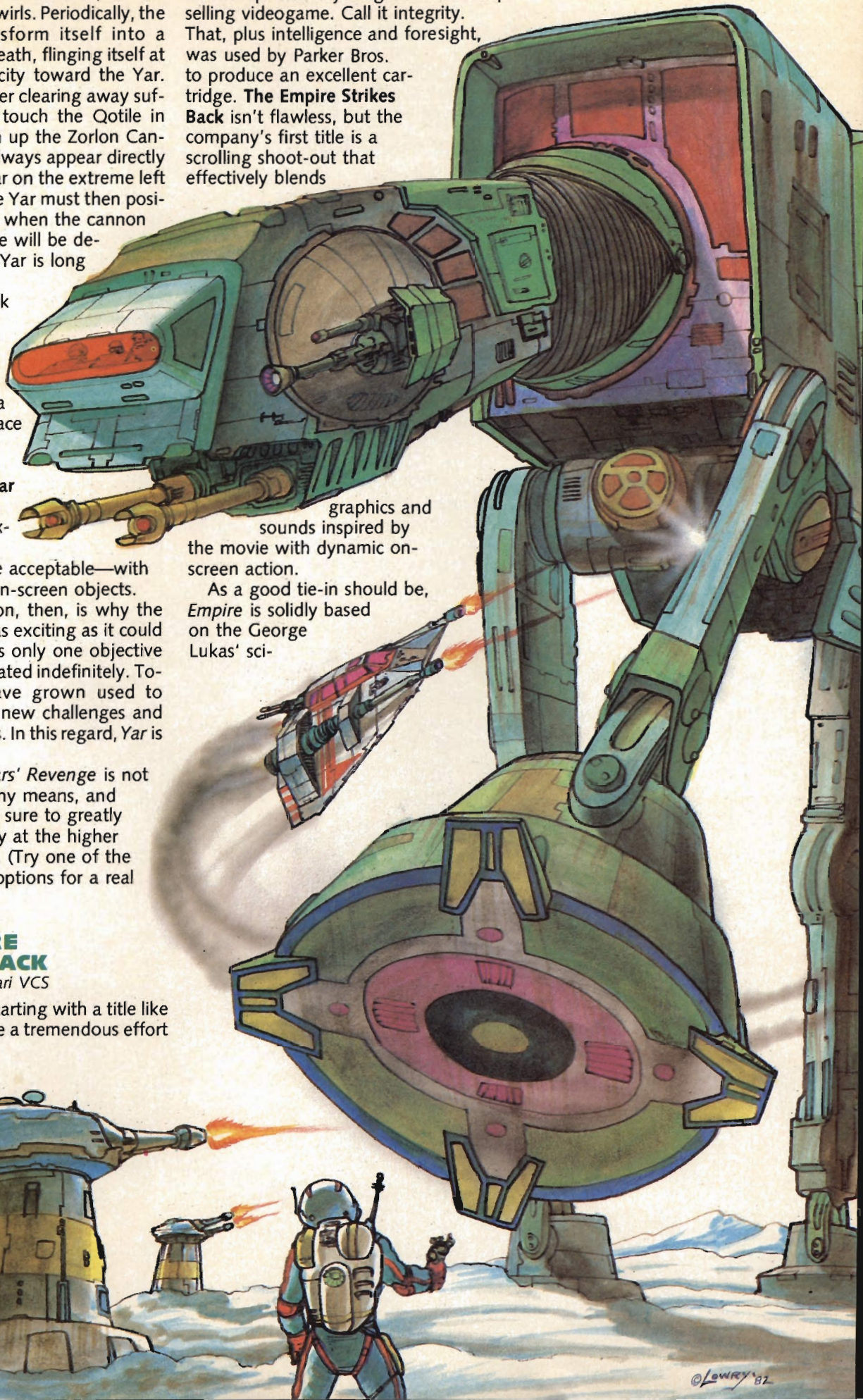



ence fantasy movie. The arcader takes control of Luke Skywalker's snow speeder in a battle to the death against a column of Imperial Walkers (or AT-ATs—All Terrain Attack Transport—as they are also called).

The action begins when the player uses his joystick to launch his first speeder into the air. Using the radar scope located at the bottom center of the main visual display, the speeder can be directed toward the line of AT-ATs that is trudging from left to right across the multi-screen layout toward the rebel Alliance's generating station on the planet Hoth.

The computer-commanded enemy is powerful, and relentless, enough to satisfy even Darth Vader. Each AT-AT can fire in a 360-degree arc, so there are no "safe zones" where a speeder can hover while dealing out some damaging blows. The metallic behemoths can take plenty of punishment as well as dish it out. The speeder must connect with 40 shots before a Walker disintegrates. The AT-AT, on the other hand, can destroy a snow speeder with just two hits.

Helping to even the fight against the Empire's awesome war machines is The Force. Its power is evident in two ways. If a snow speeder lands in one of the numerous gullies along the bottom of the playfield after taking one hit, all damage is repaired instantly.

If no snow speeder is shot for a period of two minutes, the strains of the "Star Wars" theme are heard. As long as this stirring tune plays, the speeder is totally invulnerable.

A clever bit of trickery creates the illusion of depth on the screen. The foreground scrolls faster than the background, producing a diorama-like effect. An auspicious debut.

## STARMASTER

Activision/Atari VCS

Arcaders patrol the galaxy, courtesy of designer, Alan Miller, in this strategic/tactical interstellar combat game. The player commands a spaceship on the hunt for enemy starfighters, which are swarming through our corner of the universe and destroying friendly base stars.

**Starmaster** is solidly in the tradition

of the "Trek" genre of computer videogames that by now includes dozens of titles. Miller's achievement is that he has created a space piloting contest with such richness for the VCS.

The greatest innovation in this cartridge is that the color/black & white lever on the front of the VCS console is used to toggle back and forth between the two main screens. One shows the view out the front screen of the spaceship and is used during the tactical dogfight-in-space portion of the game. The other display is a galactic map that indicates the location of all enemy starfighters and the base stars which the player must protect. The attacking aliens are programmed to surround and then demolish one base star after another, so choosing the right place to send your defender via the ship's hyperwarp engines will go far to determine whether you finish the game as a hero or a casualty.

**Starmaster** is the type of videogame that really has staying power. There is such a wide range of play possibilities that boringly repetitive play is largely avoided. 





# STAR WARS™

**THE EMPIRE STRIKES BACK™**  
VIDEO GAME CARTRIDGE

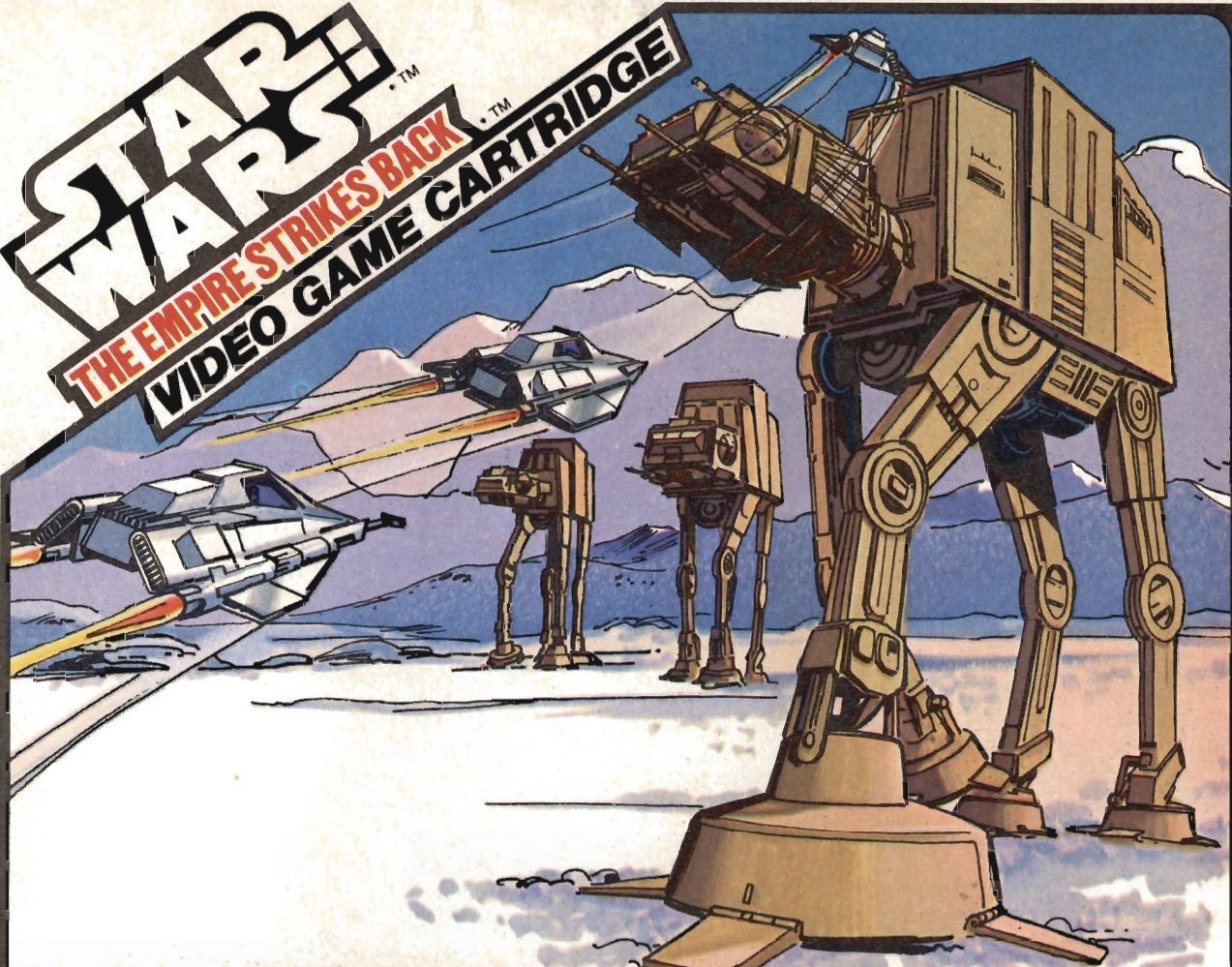

**BRING THE BATTLE HOME!**



The Imperial Walkers are moving toward the Rebel base on the Ice Planet Hoth.\*™ Can you destroy them before they blow up the power generators? Quick, into your Snowspeeders!™™ Launch your attack! You can stop the Walkers



with a perfect shot at the flashing bomb hatch. Take careful aim! Fire! KAPOW! But more Walkers are coming. They attack with deadly missiles and smart bombs. Shoot them down or be destroyed! May The Force Be With You!™

For your Atari Video Computer System™ and Sears Video Arcade.™

**PARKER BROTHERS**

© Lucasfilm Ltd. (LFL) 1982 \*™ Trademarks owned by Lucasfilm Ltd. (LFL) and used by Parker Brothers under authorization. Sears Video Arcade™ is a trademark of Sears Roebuck and Co. Atari® and Atari Video Computer System™ are trademarks of Atari, Inc.



# VIDEOGAME PREVIEW

Continued from page 37

the pack among its trio of VCS releases, the Intellivision version of this space invasion thriller is even more stunning. Squeezing every last drop of graphic juice out of the Master Component, this edition follows each successful round against the swooping invaders with a blast-off sequence that takes the gamer's ship right into the demon's lair itself. The graphics are among the most breathtaking visuals ever seen on any videogame, computer or coin-op.

Other Intellivision programs on the way include **Beauty & the Beast**, a **Donkey Kong**-like contest; **Atlantis**, the defense of a series of underwater cities from alien invasion; **Swords and Serpents**, an underground adventure; and this year's winner of the most offbeat videogame award, **Micro Surgeon**, based loosely on the film "Fantastic Journey" wherein gamers trek through a human body, clearing up blood clots, tumors and such before exiting through the nose, mouth or tear ducts.

The Intellivision group of games is far and away the strongest material yet seen for that system from an independent producer. In fact, excluding sports games, these programs are actually superior to much of Mattel's own product. Not only are the graphics breathtaking, but even the sound effects, always a problem on this system, have taken a quantum leap. Explosions, lasers and even the clanging of metal on metal as warriors battle with swords are all spectacular.

The Atari VCS line looks similarly strong, with an impressive version of **Atlantic**, the action/adventure **Riddle of the Sphinx**, **Fire Fighter** and the innovative SF contest, **Cosmic Ark**.

Imagic is now firmly established as a software force, with only the Activisionaries maintaining a stronger position. In terms of Intellivision software, however, Imagic is without peer.

Imagic has also announced, as reported in the Odyssey section, that it will introduce the first independent piece of software for the O<sup>2</sup>—the ubiquitous **Demon Attack**. The company has begun a club and newsletter, the "Numb Thumb Club", and will be sponsoring a "Defend Atlantis" tournament later this year.

All in all, videogamers should be in their glory this holiday season! ☺

# COLECO'S PAC-MAN CONTROL WIRING CONNECTIONS

## PAC-MAN

PRIMARY JOYSTICK WIRING PLAN

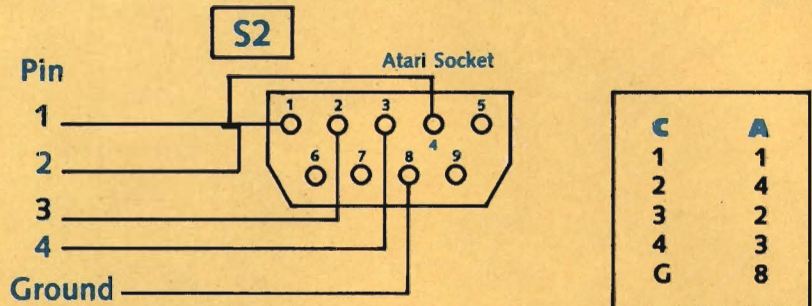

## GALAXIAN

PRIMARY JOYSTICK WIRING PLAN

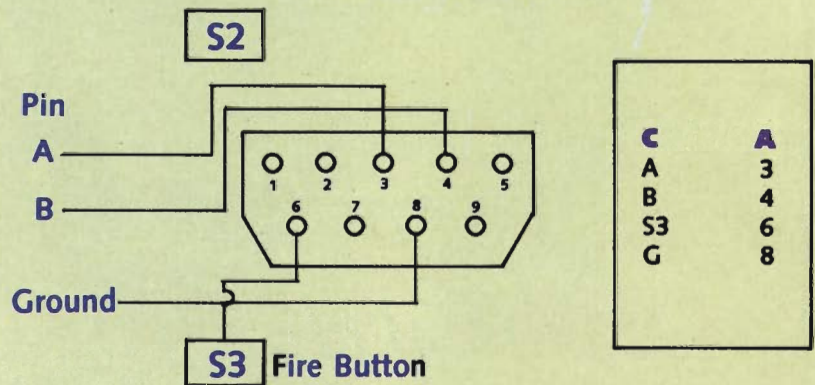

## AC ADAPTER WIRING PLAN

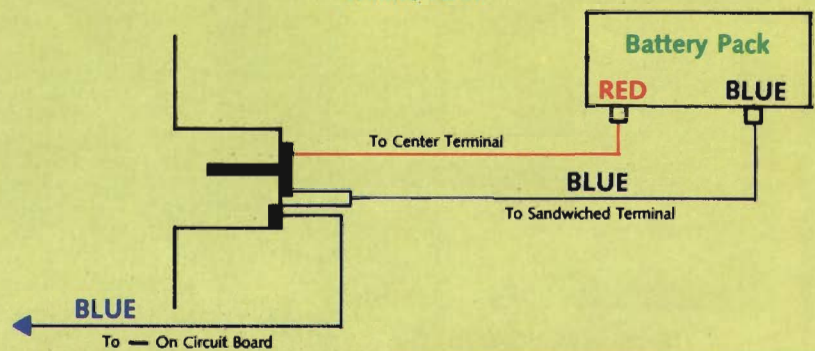

## SPEAKER WIRING PLANS

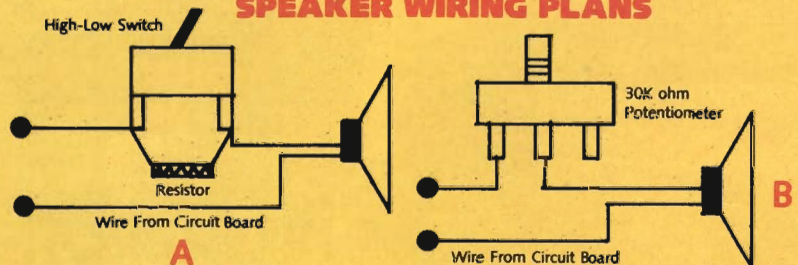





Astrocade™...the home video game that's a personal computer too!

3  
Built-in  
Games

Built  
in  
Calculator

3 Octave  
Music  
Synthesizer

256  
Color  
Variations

4  
Player  
Capability

Basic  
Program

astrocade™

The Professional Arcade™

6460 BUSCH BLVD., SUITE 215 COLUMBUS, OHIO 43229

Manufactured under license from Bally Mfg. Corp.



# COMPUTER PLAYLAND



## Brave the Perilous Skies of World War II!

### NIGHT MISSION

Sublogic/Apple III/48K disk

It's either feast or famine in the computer software game. Until mid-1982, **Raster Blaster** stood alone as the only first class computer pinball simulation. Then, virtually simultaneously, came **David's Midnight Magic** (Broderbund) and **Night Mission**.

Which is the best? It's hard to say, because personal taste in flipper-game action will be the deciding factor for many gamers. Quite a few will probably want to purchase all three, because each is so individual. After all, most of us own more than one invasion game, maze-chase or scrolling shoot-out.

If *David's Midnight Magic* is reminiscent of the artful simplicity of some of the venerable Williams pinball tables, then *Night Mission* instead should remind many of the feature-loaded tables produced by Bally and Gottlieb. This game, which is based on the theme of an after-dark World War II bombing run, has everything from a kick-out hole to rotating lane lights. In some situations, as many as four balls can be zooming around the screen at the same time.

The meticulousness of the simulation is awesome. For instance, it is necessary to press the "Q" key, which puts a quarter into the on-screen slot to begin a game. The program also awards free games for high scores or making appropriate bonuses. It even gives a free game if the last digit of the player's score matches a randomly

generated number, just like many of the coin-op flipper games do!

But the truly amazing thing about *Night Mission*, overshadowing all of its other plusses, is that it is user-modifiable to an incredible degree. The game comes with nine complete modes already in place, but there's room for about 100 configurations created by the gamer. Once the computerist has entered the proper mode by typing "Fix", it is possible to individually adjust 20 separate elements in the game—everything from the number of phantom ball trails to the sensitivity of the tilt mechanism.

At times, the *Night Mission* playfield seems to get almost too busy. When this game gets really wound up, it may sometimes seem like it's playing on automatic (even when the self-play option is not engaged). This could be somewhat disconcerting to videogamers who are used to controlling the action at all times. Still, it must be admitted that this is precisely what happens on many full-sized pinball machines when they go into high gear.

(Arnie Katz)

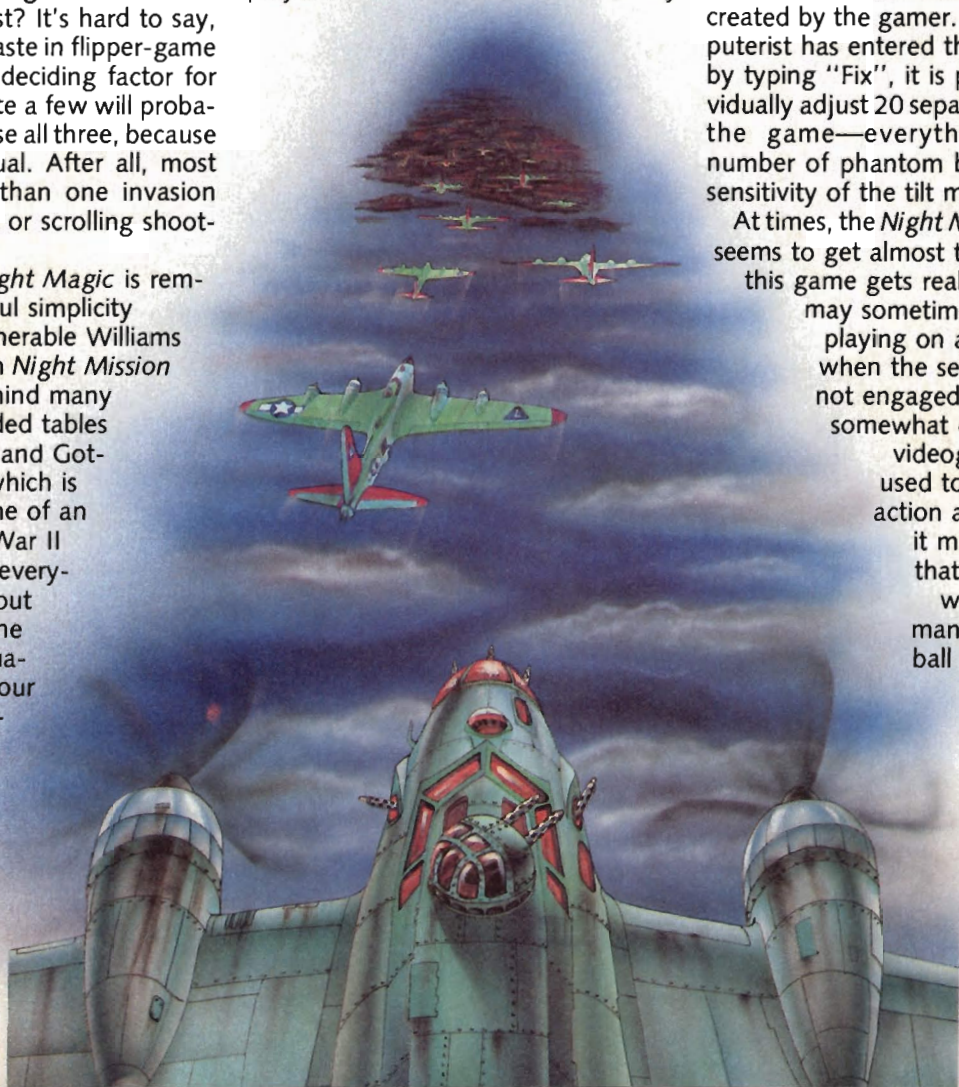



# MOONBASE IO

● the battle for the moons of Jupiter ●



Blast your way through the alien mine fields! Defend the moonbases from an attacking alien armada! It won't be easy.

To win you will need to mount a heroic assault on the alien mother ship.

**Moonbase Io** combines three exciting arcade adventures in one exciting game. The machine-language program by John Konopa uses advanced graphics and sound effects. Action is fast and exciting — varying levels of skill required to go from one part of the game to the next.

Disk version requires 16K ATARI® computer with disk **and** cassette. Cassette version requires 16K ATARI® computer with cassette.

BEYOND SOFTWARE's arcade-adventures are the next generation in computer games for the ATARI® computer.

A voice-activated program will help you meet and overcome the challenge — it may be an alien invasion, a fiendish murderer preying on a country village or a treasure trove buried deep in the shark-infested sea.

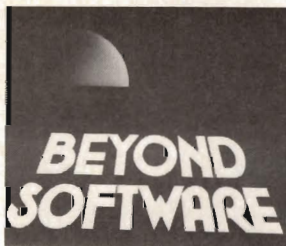

**Moonbase Io** is available at fine computer dealers. Or, directly from PDI for \$29.95 plus \$2.00 shipping and handling.

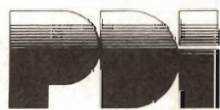

Program Design, Inc., 11 Idar Court, Greenwich, CT. 06830 203-661-8799

ATARI® is a registered trademark of Atari, Inc.



## SNACK ATTACK

Datamost/Apple II/48K disk

This delightful game for the Apple II computer involves a hungry whale, a sea of gumdrops and a quartet of pursuing guards. Playable with either the keyboard or joystick (preferable), **Snack Attack** has the arcader guiding the famished fish around three entirely different maze-like playfields. Each one is stocked with four energizing elements—magic stars, actually—that, when eaten, give the whale the power to chomp the guards.

More than a few readers will find this play-routine . . . familiar. Fortunately, the graphics, maze structure and audio effects raise this title far above other maze-chases created for this popular microcomputer system.

One important difference from **Pac-Man** is the presence of horizontal green and vertical purple doorways in the walls of the labyrinth. The whale has the advantage of being able to swim through the green portals, while its just another solid barrier to the guards. On the other hand, the goon squad can make timely use of the purple doorways, but the whale must go the long way around.

There are even gumdrops located within the central pen area, which is sealed by the magic doors, so this feature can't simply be ignored. And don't try to leave through the trap door!

The audio/visual aspect of *Snack Attack* is, however, its most endearing quality. Highlights are the undulation of the whales mighty fin as it swims

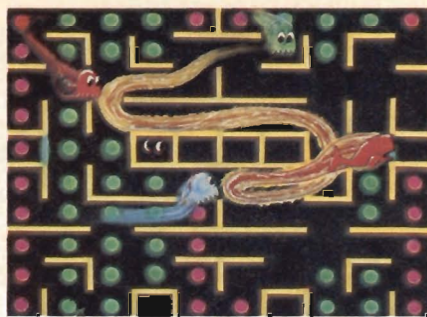

SNACK ATTACK

through the candy cove, the gulping noises and the way the seagoing mammal "blows up real good" (as they say on "SCTV") when it runs out of running room.

If Datamost can do this well when trodding well-worn paths, arcaders can only wonder what type of programs this supplier will publish in the way of games with more innovative play-mechanics. For now, we can only wait with keen anticipation—and have a good time with this top-of-the-line gobble game. (Bill Kunkel)

## CRICKETEER

The Software Farm/Apple II/48K disk

"Life ain't easy for a lowly cricket" begins the instructions for this one-player traffic-dodging contest. After you've tried to guide one of the little bugs across the four-lane highway, over the dreaded Black River and then through some unsuspecting homeowner's front door, the odds are good that you'll consider that remark an understatement.

Reviewers in this column have increasingly rapped the knuckles of software producers who do not program their arcade-style games to utilize joystick input. This is a keyboard game—"A", "Z", left arrow and right arrow represent, up, down, left and right—but that doesn't create quite as much of a problem as it does in many other games. Movement is simple enough to handle using the equivalent of four buttons, and designer Rod Nelson has thoughtfully provided the option of re-assigning the directional commands to different keys if the gamer so desires. Still, there's no substitute for the ease of joystick control, and it is to be hoped that Nelson will take this into consideration when putting together his next effort.

Each round of play consists of getting five crickets through this obstacle course. Jumping the final insect into the left-most house is quite tricky, so beginners will find themselves competing on the first level a good deal of the time. Getting a cricket safely home earns 200 points, with the possibility of a bonus of another 200 if the bug has managed to snag a food particle along the way. Jumping into the same space as a lady cricket and then escorting her home is worth a 500 point bonus. A complete round boosts the score by 1,000 bonus points. Bonus points are also awarded for the amount of time remaining on the clock after the gamer steers a cricket past the various obstacles.

Partially making up for the lack of





joystick control is the option to skip the first two rounds of play. Once you become fairly adept at **Cricketeer**, this will allow you to skip what will have become the least interesting portion of the game.

The traffic portion of the game is nothing special, but the trek across the Black River holds more interest. It seems that a disgruntled employee of a tongue depressor manufacturer has blown up the plant and choked the waterway with the destroyed firm's product. The surf-board-shaped depresses serve the crickets as a floating bridge, though player's must look out for depressors that sink to the bottom of the river, leaving the cricket riding on top of it in a deadly fix.

*Cricketeer* is clearly aimed at fans of the popular coin-op game, **Frogger**. The course of play is very, very similar, though *Frogger* is definitely the superior design, especially from the point of view concerning art and sound effects.

Still, it's an amusing game that's also tough to play. (Arnie Katz)



The play mechanic is a scrolling shoot-out in the **Scramble/SuperCobra** familiar. The gamer maneuvers a laser-wielding aircraft through weapon-infested caverns and asteroid fields that become progressively more treacherous with each successful trip.

Designer S.A. Riding offers one- and two-player modes with five levels of difficulty. Anti-aircraft missiles can be destroyed either before or after launch (which always occurs an instant before the player's ship passes overhead). The pilot can accumulate additional ammunition by destroying the clearly-marked ammo dumps

along the way.

The horizontally-scrolling spaceship can be moved vertically, with speed determined by left and right joystick movement.

After passing through the caverns,

### AIRSTRIKE

English Software Co./Atari 400 & 800  
tape and disk/32K

This is the first British-produced piece of computer game software received here at EG. If it's a sign of things to come, then Hail, Britannia!

the ship enters an open area of space in which asteroids fall like raindrops on Picadilly Circus. The space rocks can be either destroyed for points or simply avoided. At the end of the asteroid field, the aircraft reaches a spacewall which can only be breached by blasting through the yellow airlock

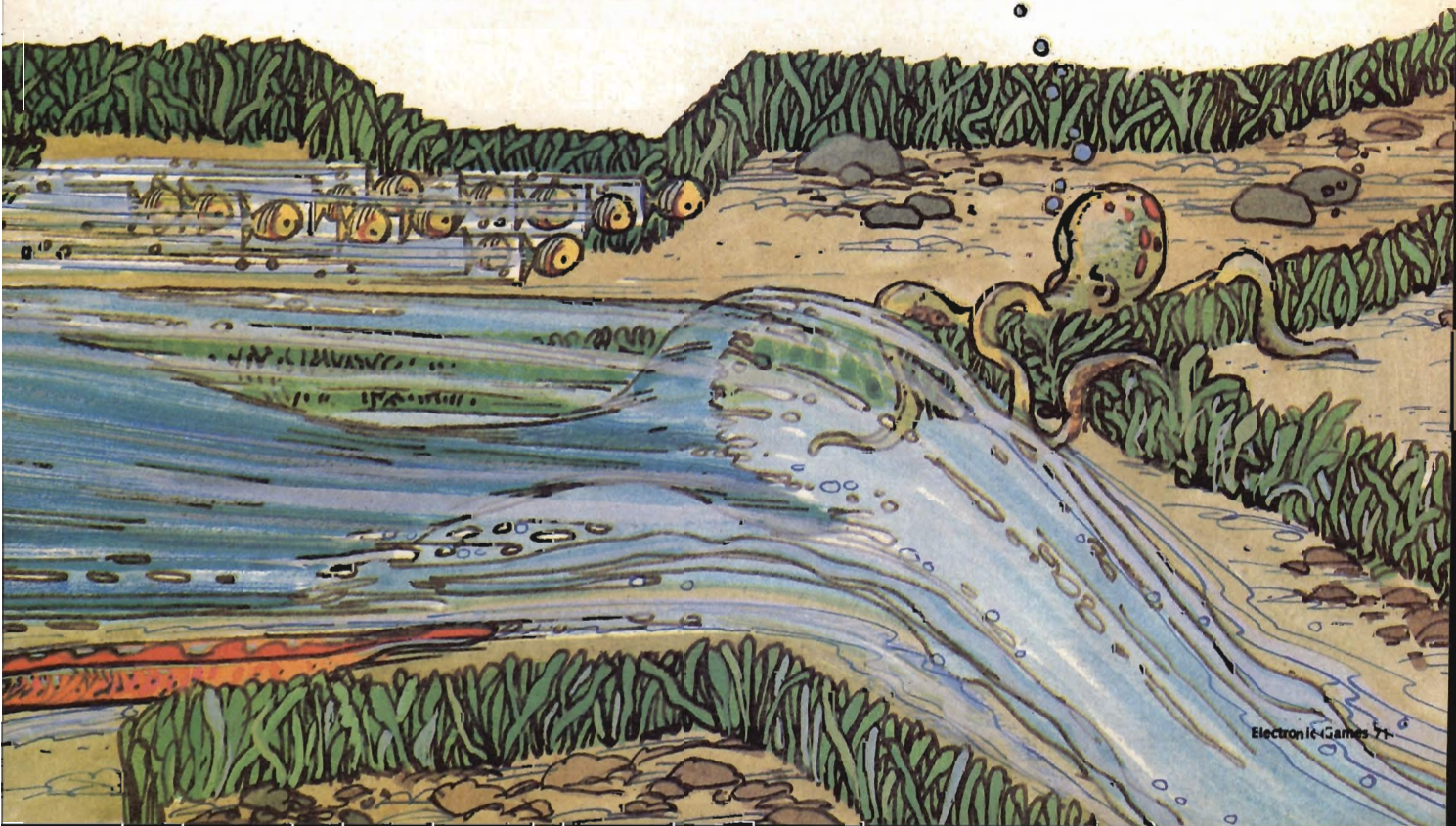





in its belly. This accomplished, the playfield changes background colors and begins the second scenario, which only differs from the first in difficulty.

The graphics are absolutely top-notch, perhaps the finest recreation of the sort of coin-op which inspired *Airstrike* in the first place. The audio mixes a potpourri of sounds, each representing a different visual element, from the hiss of the asteroids to the whoosh of a launching missile.

With *Airstrike*, English Software shows it can produce coin-op look-alikes with the best of them. A new game, however, with a more original play concept would establish this company as one of the best software producers around.

(Bill Kunkel)

## JUPITER LANDER

Commodore/VIC-20/ROM cartridge

Few action games adapt well to keyboard control. Quick reflexes and immediate response are usually better handled by joysticks or paddles. Because of this, it was both a surprise and a pleasure to find an action-oriented simulation that actually benefits from using the keyboard rather than the more familiar type controllers. *Jupiter Lander* is a high-resolution, full-color "kissin' cousin" to the familiar arcade *Lunar Landing*.

The object of the game is to softland your spacecraft on one of three landing sites. To achieve this end, the game employs five controls. Three will usually bring the spacecraft down to a successful landing. The computer uses the "A" and "D" keys for left and right horizontal thrust, and the specialized F1, F2 and F3 keys, located on the far right of the keyboard, for varying degrees of vertical power. In play, the F2 and F3 keys appear to be unnecessary as their thrust levels are too low to appreciably affect flight.

Each of the landing sites applies a point value multiplier to the amount of fuel consumed in making a successful landing. The easiest site is marked 2X, the middle range of difficulty is valued at 5X and the most difficult area is 10X.

Fuel consumed during a landing depends upon your skill as a pilot. A gauge, visible along the bottom of

the playfield, informs you of on-board fuel conditions. Unlike the arcade versions of this simulation, no abort button is provided. Once committed to a landing, you're on your own.

As with most VIC-20 ROM cartridge games, a demo/instruction mode is built into the system. It's a clever touch that lends a real arcade feeling to the games. To begin play, simply touch the F1 key and, after a short fanfare and beeping countdown, your spacecraft begins to descend from the upper left corner of the screen to the lower right. Jupiter looms below, a bright orange planet with three plainly visible landing sites carved into its surface.

Space cowards and novices should try for the central (2X) target zone, landing atop a flattened mountain, while veterans will head for the farthest and most difficult site. This is located on the far right of the screen and will take you into a cavern deep within the planet.

No matter which landing site you choose, pay strict attention to the meters per second (M/S) gauge located on the far right of the screen. This vertical column contains a small shaded area at its midpoint which signifies the proper descent rate. A black horizontal bar must be kept in this area when actual touchdown occurs. If the descent rate is above or below the proper level, no points are awarded for the landing and the spacecraft explodes.

Points are figured, after a successful soft landing by taking the amount of fuel consumed, factoring it by the po-



JUPITER LANDER



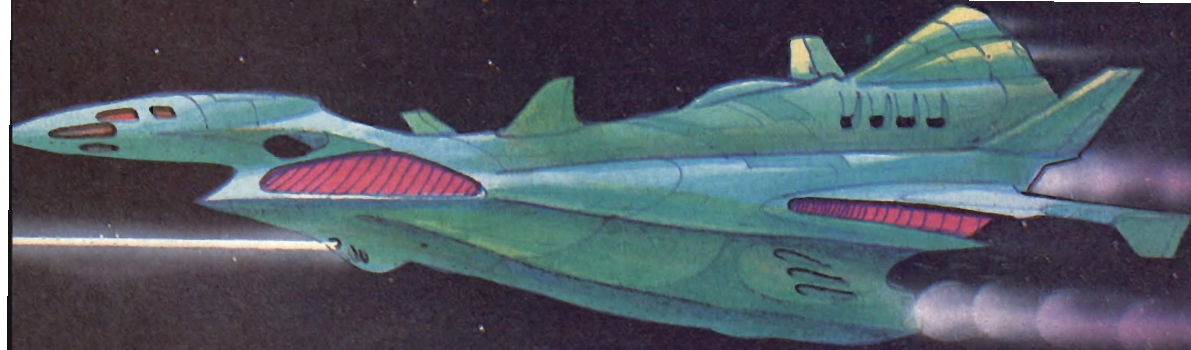

sition of the meters-per-second gauge and multiplying it by the difficulty of the landing site. It sounds more complicated than it is. Simply keep the *MS* gauge as close to the top of the shaded area as possible for the most points. Depending upon the number of points awarded, fuel is allocated back to the spacecraft. The more points, the more landings that can be made.

Remember, gravity brings the spacecraft down, but finesse on the *F1* thruster keeps the spacecraft from crashing. It takes a practiced, light and repetitive touch on the thrusters to keep things under control.

(Henry Cohen)

## TUMBLE BUGS

Datasoft/Atari 400 & 800, Apple II/48K disk

Originally entitled *Dung Beetles*, **Tumble Bugs** has been released for the two most popular gaming microcomputers by a company heretofore most famous as a publisher of adventure games. It is a maze game that embodies something of the flavor of **Pac-Man**, but it also possesses an interesting twist.

As with many programs available for both the Atari and Apple computers, *Tumble Bugs* seems a bit better on the former machines than on the latter. The Atari's superior sound capabilities and high quality joystick give it a little edge over the Apple II version, though that one is also excellent.

The opening screen in *Tumble Bugs* is riveting. A large beetle stares directly at the player, positively daring him or

her to begin the attack. The computer then draws a large maze which must be memorized by the gamer during the brief period in which it is visible. When the game actually starts, only a small portion of the labyrinth can be seen at any one time. The program gives the player a magnified view of the hunk of maze currently occupied, while the rest stays surrounded in mystery.

As in *Pac-Man* and other maze-chases, *Tumble Bugs* requires the arcader to zip through the corridors and eat all the dots. Little aliens travel through the maze, too, but they aren't very smart and can usually be avoided, at least in the beginning. The aliens get tougher to avoid, however, and they eventually pounce on the player with a cry of "gotcha!"

There's tremendous pressure to keep gobbling those dots, rather than navigating the maze in a pure contest of evade and capture. The action is timed, and failure to keep munching will cause your score to decrease. *Tumble Bug's* graphics and sound represent first class programming skill. The screen layouts are attractively done and pleasingly colored. The implementation of the magnifying glass effect is especially impressive. Even the on-screen scoreboard is shown in enlarged form when the glass passes over it in the course of highlighting various sections of the playfield itself.

Bob Bishop has further enhanced his budding reputation as a member of the game programming elite with this fine effort. Highly recommended.

(Leigh Goldstein)

## POOL 400

IDS/Atari 400 & 800/ROM cartridge

Innovative design has made quite a reputation for itself among Apple II-owning gamers with its string of successful disks for that system. Now the company has enlarged its electronic pool hall to provide sufficient room for Atari computerists. **Pool 400** packs much of the detail of IDS's *Pool 1.5* into an easy-to-use ROM cartridge for the Atari microcomputers.

The most exciting feature of this generally well-executed game is the "instant replay". When you send the cue ball into the side pocket with this game, you get a chance to try the whole shot over again. Too bad real-life pool sharks aren't quite that amiable about such things.

*Pool 400* will be especially welcomed by those who don't have lightning reflexes. Good strategy and a sharp eye for geometry count far more heavily.

(Steve Davidson)





It's truly amazing the way weird stories get around these days. It seems like everybody knows someone who knows someone who invented an automobile tire that never wears out or a pill that lets a car get 200 miles to the gallon of water.

The electronic gaming world possesses no immunity in this regard. One story which has received especially wide circulation concerns the subject of this month's "Inside Gaming" column, Mark Turmell.

Several articles which followed on the heels of the success of Turmell's outstanding debut game for the Apple II computer, *Sneakers*, attempted to profile the new design star. These stories informed gamers that Mark Turmell is a medical doctor, perhaps in his early thirties, who created *Sneakers* during spare moments between performing delicate operations.

So it was something of a shock when the tall string bean ambled up to me and introduced himself as Mark Turmell. With every sentence he uttered during our lengthy talk, another section of the picture these error-filled ar-

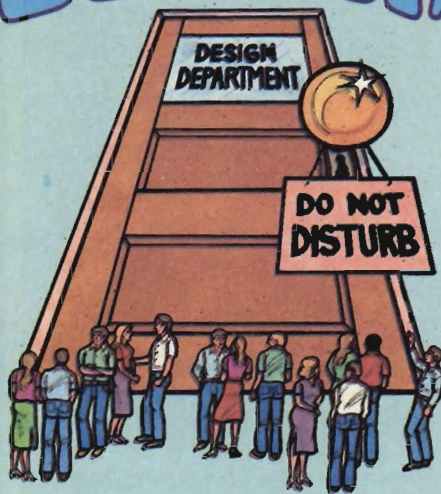

## The Real Truth about Mark Turmell

by STEVE DAVIDSON

ticles had created in my mind crumbled away to dust. Yet in the course of replacing fantasy with fact, it became clear that the real Mark Turmell is even more interesting than that non-existent physician-turned-game designer.

While many of the people now active in the electronic gaming world either stumbled on a career in game design by accident or drifted into it from another field, the 20-year-old Turmell is a genuine computer kid who made good. Despite his youth, the affable Sirius Software employee already has five years of programming experience under his belt.

Something of a whiz kid, Turmell started college at the tender age of 15. He attended Delta College in University Center, Mich., and graduated with an associate of arts degree in Data Processing; just about the time they also handed him his high school diploma.

The same year he entered college, Turmell's life took a decisive turn toward his future chosen career when he got his first Apple computer. Even then, Turmell had some definite ideas about where he was headed. "I bought the Apple for two reasons," he recalls, "to make games and make money."

In a surprisingly short time, Turmell

had learned his way around the Apple, particularly its graphics capabilities. Not being one to stand around with his hands in his pockets, he immediately began working on his first game program. "I wrote *Head On*, a crash game," he says, "which I took to Programma International, which has since gone out of business." The company gave him a contract and was expecting to publish *Head On* when another software supplier beat them to market with a strikingly similar game. *Head On* went back to the electronic garage.

He began working on *Sneakers* while attending Ferris State College in Big Rapids, Mich., where he pursued a degree in data processing with a minor in marketing. On his own, he was also learning Assembly language, which he felt would be necessary if he was to become a really first-rate programmer.

"*Sneakers* only took about three months to write," Turmell says. Most of the work was done utilizing Sirius Software's E-Z Draw. "It's a great product for designing games," he explains. "I never use anything else."





ComputAbility  
presents the Newest in Joystick Products

# Starfighter & SLIK STIK™

## Starfighter™

- 2 year warranty
  - Lasts longer
  - More accurate
  - Less fatiguing
  - Easier to hold
- \$16.95



Lefty Joystick Adapter  
Adapts to any Atari-type joystick. Moves fire button to top right.

\$9.95

Extension Cable (5ft.)  
Adapts to any Atari controller.

\$6.95

## SLIK STIK™

- 90 Day warranty
  - Same as Starfighter except made of softer material
- \$9.95



All joysticks work with:  
 ● Atari VCS ● Commodore VIC-20  
 ● Sears Telegame ● Atari 400/800  
 All products above have registered trademarks.  
 We also carry a large selection of Atari and Commodore software.

Mastercard/Visa  
Order Toll-free:  
800/558-0003

In Wisc. call:  
414/351-2007

Send check or money order to:  
COMPUTABILITY. Add \$2.50 shipping & handling. WI res. add 5% sales tax. Price and availability are subject to change without notice.  
ORDER HOURS:  
12pm-9pm  
Mon.-Fri.  
CTS  
30 day guarantee.

ComputAbility  
PO Box 17882  
Milwaukee, WI 53209

# Looking For Electronic Games?

## ELECTRONIC GAMES RETAILERS

If you have trouble finding ELECTRONIC GAMES at your local newsstand or want to know where to send a friend to pick up a copy, the following will help. It's a list of retail stores across the country that carry the magazine.

### ARIZONA

All Systems Go, Tempe  
Niles Radio & TV Renter, Inc., Tucson  
Videocade, Tucson

### CALIFORNIA

Ancrona Ltd., Los Angeles  
Games, Van Nuys  
Gamesmanship, Santa Ana  
HW Electronics, Northridge  
Software Central, Pasadena  
Video 2001, Inc., Los Angeles

### DISTRICT OF COLUMBIA

Program Store, Ltd., Washington

### FLORIDA

Video City, Inc. Ft. Lauderdale

### GEORGIA

Young Entertainment, Inc. Atlanta

### LOUISIANA

Computer Shoppe, Metairie  
Video Connection, Metairie

### MASSACHUSETTS

Movies To Go, Newton

### MICHIGAN

Maxaron Corp., Warren

### MINNESOTA

Discount Video, Minneapolis

### MISSOURI

Liberty Sound, St. Joseph

### NEW HAMPSHIRE

Video Station, Inc., S. Merrimack



### NEW JERSEY

Ippys, Manasquan  
J&H Hobby Center, Vineland  
Magic Fountain, Hoboken  
Video Connection, Cherry Hill  
Video Track, Marlboro

### NEW YORK

Captain Video, New York City  
Captain Video, Pomona

Flatbush Video, Brooklyn  
Fran's Place, Conram  
Gold'n Video, Elmford  
Kingsway Video, Brooklyn  
LVR Video, Manhasset  
Micro Center, Amherst  
Parkway Video & Electronics, Brooklyn  
Software Supply Intl., Inc., Niagara Falls  
Staten Island Computer Center, Staten Island  
Video Connection, Cedarhurst  
Video Hut, Inc., Flushing

### OKLAHOMA

On Line, Oklahoma City

### PENNSYLVANIA

Craftut, Reading  
Games Unlimited, Pittsburgh  
Movies Unlimited, Philadelphia  
Parke T. Morrow, Inc., Erie

### TEXAS

Irving Video, Irving  
Games Peddler, Inc., Houston

### VIRGINIA

Big Picture, Arlington  
L & T TV Sales, Woodbridge

### WASHINGTON

Games People Play, Poulsbo

### WISCONSIN

Video World, Waukesha

### PUERTO RICO

Video Sonics, Hata Rey

### CANADA

KO Enterprises, Ltd., Oshawa

(ATTENTION: If you carry 25 or more copies of ELECTRONIC GAMES in your store and are not included in this list, please let us know so that we can include your store in our next issue.)



A brief explanation for those unfortunate enough not to have seen *Sneakers*, one of the most popular games ever published for play on the Apple. It is a multi-screen invasion contest in which a variety of humorously drawn creatures attack the horizontally mobile cannon commanded by the arcader. Each time a wave is cleared from the board, another species of monster launches an attack. Every group has its unique attack strategy, so the gamer must employ an amazingly wide range of play strategies to get through this video war in one piece.

Like many of his fellow designers, Turmell doesn't watch the clock when he's seated in front of his computer. Many times, he worked right through the night on *Sneakers*. "When I'd get an idea for one of the screens, I'd go on a tear," he notes.

Apart from the many, many hours of work involved in creating his action

that it is sometimes hard to squeeze the action button on the controller fast enough to dispatch the nasties, Turmell staunchly defended the hardware. "One of the reasons *Sneakers* works so well is that the Apple paddle is so responsive," he asserts. "It was my programming mistake that created whatever problem some players are finding. I programmed the game so that only one shot could be on the screen at a time. It's just a mistake—and something I'd do differently now.

Although Turmell has done *Beer Run* and *Free Fall* for Sirius since *Sneakers* scored big with arcaders, most of his recent work for Sirius has concerned the new line of videogame cartridges (VCS-compatible) that 20th Century Fox is developing for release this fall. Two of the titles will bear his distinctive design imprint, *Fast Eddie* and *Turmoil*. The first is a ladder game in which the on-screen character

must jump through the air and snag prizes on the fly. The latter is a space shoot-out which allows the arcader to fire a barrage of up to eight laser blasts.

Turmell is very forthright in discussing his reasons for directing his creative energies primarily at videogames,

at least for the short run. "The videogame field is more sparse than computers, with not as many 'elite' programmers working. "I want to be a known person," he admits, "and the going may be a little easier in the videogame area."

Besides his observations of coin-ops made during the course of frequent visits to the local arcades, Turmell looks to friends and acquaintances to serve as a sounding board. "I usually bounce the idea for a new game off at least 50 people," he says. Home arcading, on the other hand, is only a sometimes thing for the young game-maven. "I'm just used to arcade games, I guess," says Turmell.

He's also very sensitive about maintaining a good reputation among the other designers. "The one thing I'm really picky about is the other programmers' judgments," he says. "I don't want them to say, "I could have done it better."

And anyone who has played his uniquely whimsical electronic games knows that this is a comment the formerly mysterious Mr. Turmell hears very seldomly, indeed.

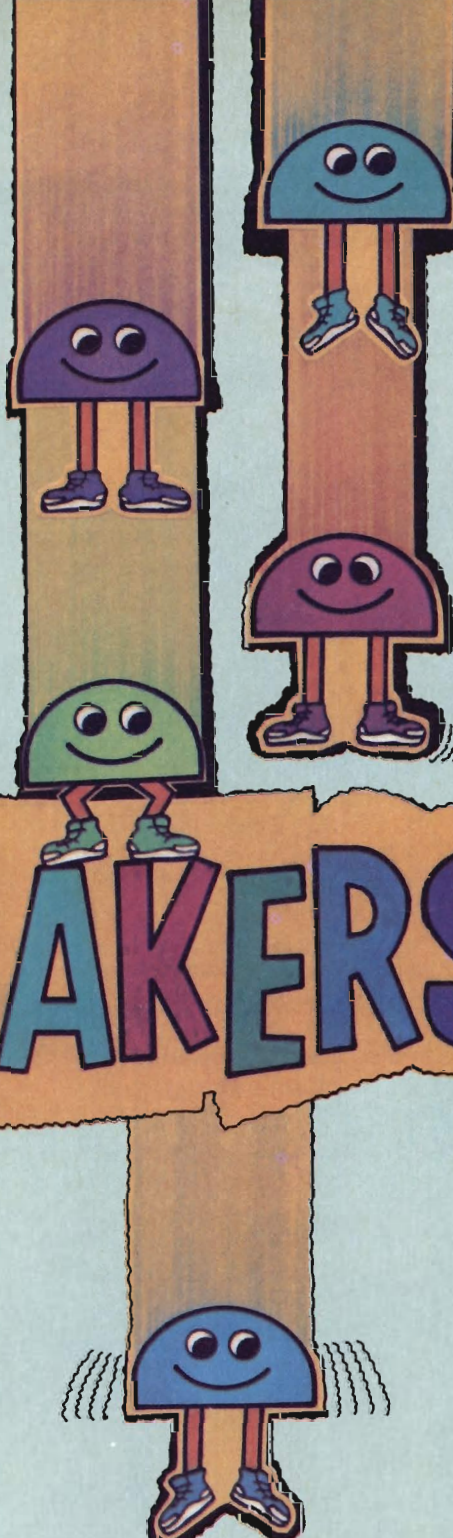

# SNEAKERS

smash hit, Turmell found the going surprisingly easy. "I kept waiting for some obstacle, like running out of memory, to come up, but it never did."

Graphics were definitely the toughest part of the project. "My biggest challenge was in getting flicker-free animation with color. Doing the meteor screen was the toughest for that reason.

"Turmell is candid about having looked to the commercial amusement centers for the original inspiration for *Sneakers*. "Gorf from Midway had a little guy bouncing around the screen," he points out, "and *Astro Blaster* had the idea of multiple playfields.

Fittingly enough, the first character Turmell designed for the game was the Sneakers, those zany creatures with their oversized footgear who appear as the first screen in the game. The cartoony look of the Sneakers undoubtedly established the underlying thread of humor that runs through the entire program.

The Sneakers may have come first, but the designer's favorite creation was the chirping H-wings. This hints that there may be an edge of steel beneath Turmell's affable exterior, because these horrors are among the most perilous in the entire game. They swoop down upon the single cannon from all directions and frequently score a quick kill.

Like most designers, Turmell is first on line when it comes to spotting the few weaknesses in his much-lauded creation. Responding to comments



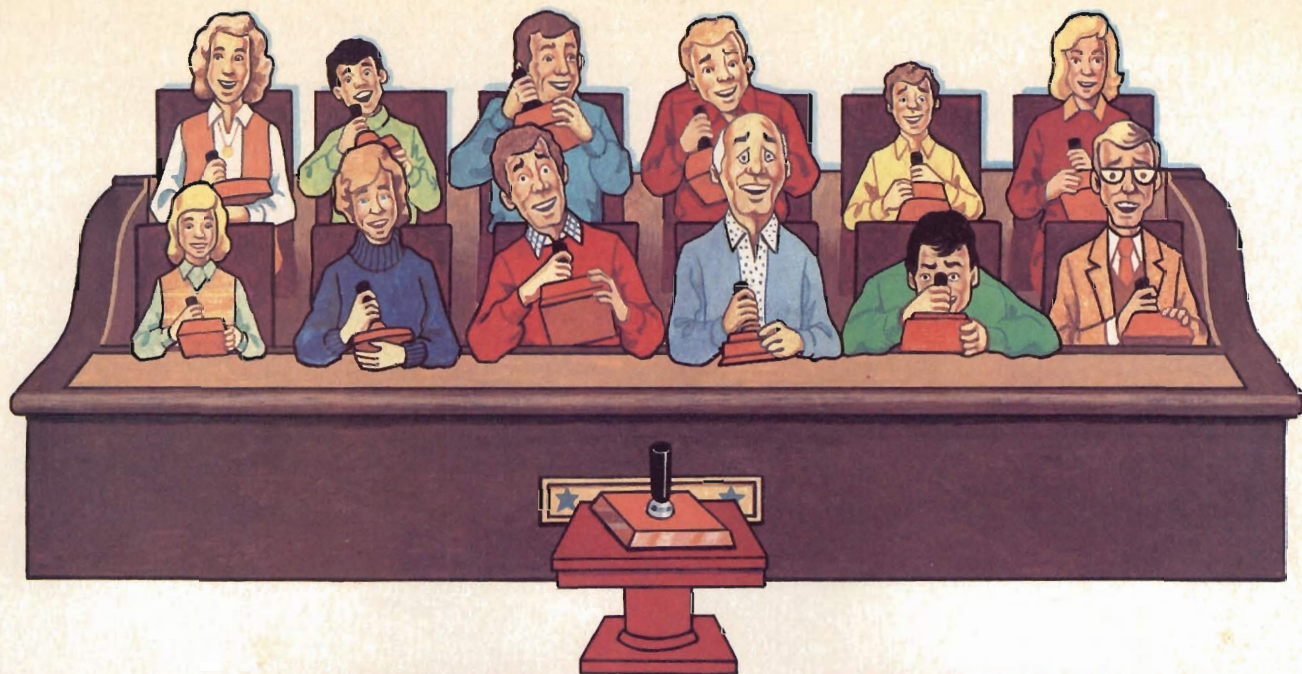

# JOYSTICK JURY

## Translations or Original Games—Which Way's Best?

**W**e expected plenty of lively debate when we decided to take the pulse of reader opinion on the subject of whether the best future direction for home videogame cartridges was toward more translations of big coin-op hits or greater emphasis on completely original designs. We got it.

In fact, no question so far has ignited the passions of the gaming public to quite the same degree as this one did. Plenty of readers have lined up on each side of this crucial question, and all of them have excellent arguments to support their positions. And of course, there's always that group of folks who can see right on both sides of the issue. This looks to be the start of a pretty exciting continuing debate. We hope all readers, not just those

who are participating in this initial skirmish, will free to make use of Electronic Games' regular forum of opinion, "Readers Replay", to add to this fascinating discussion.

Speaking of reader input, we also got quite a few comments this time around about our prize for the best contribution to "Joystick Jury". Many of you, it seems, would prefer to get a year's free subscription to EG (valued at \$28) rather than the \$25 in cash. So beginning this time—and continuing until we're really sure what readers want—we're going to give our winners a choice between these two rewards.

The best comment, out of a very strong group, comes from Chicago's Dan Silvestri. So let the great debate begin with an opening salvo from the

foreman of this month's "Joystick Jury":

Electronic gaming has made progress for two reasons: (1) technology has advanced, and (2) game designers' imaginations have been set free. We do not need to arrest the imaginations of these wizard-designers by encouraging them to spend their creative hours by translating a commercial amusement game into a home programmable videogame or computer game. Not only we do harness the designers' imaginations, but we encourage player dissatisfaction; The translations to date have been less than overwhelming.

The irony is, the "translators" are not at fault, they just can't cram a 16K, 32K or 48K game into a 4K programmable videogame.

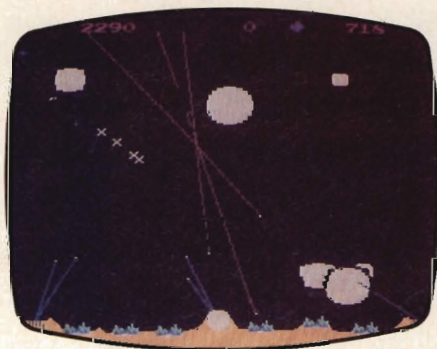

COIN-OP MISSILE COMMAND

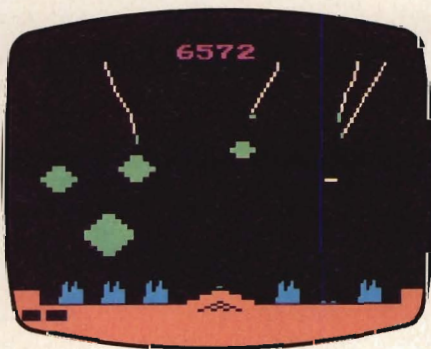

VCS MISSILE COMMAND



VCS ASTEROIDS



★**COSMIC CROSSFIRE™**★  
Video Games

ATARI Game Units and Cartridges.  
ACTIVISION Cartridges for Atari.  
INTELLIVISION Game Units, Cartridges, and Mattel Hand Helds.  
INTELLIVOICE and Games.  
APOLLO, IMAGIC, PARKER,  
U.S. GAMES  
??CALECO??

**Computers**

ATARI 400 and 800, Software, Games  
COMMODORE VIC-20, Software,  
Games  
★★Send TODAY for confidential★★  
★★price list★★

**Electronics**

As a service to our preferred customers, the Eagle has added a comprehensive, DISCOUNTED, name brand, electronics merchandise catalog. This 300-page catalog is FREE to purchasers of \$70.00 or more in games or computers. Order your games now to get your FREE catalog.

★★Supplies Limited★★

**EAGLE ENTERPRISES**

P. O. Box 56096  
Little Rock, AR 72215  
(501) 851-3830

Retailer: Reese Publishing Co., Inc. is pleased to announce a Retail Display Plan available to all retailers interested in earning a display allowance on Electronic Games who purchase the magazine from suppliers other than Dell Distributing, Inc. or the publisher. To obtain details and a copy of the formal contract, please write to Progressive Magazines, Inc., Director of RDA, P.O. Box 574, Fair Lawn, N.J. 07410. Under this plan, in consideration of your acceptance and fulfillment of the terms of the formal contract to be sent to you upon request, you will receive a display allowance on all copies sold by you. This plan will become effective with all issues of Video delivered to you subsequent to the date your written acceptance of the formal Reese Publishing Co., Inc., Retail Display Agreement is received and accepted by our company.

**We need  
your support.  
Your gift  
is the gift  
of love.**



**American Heart  
Association**

**WE'RE FIGHTING FOR YOUR LIFE**

Let the quarter-popper within us all have a reason to go out to a game room or bar; let's see something different there we can't get at home. And let's have something at home that's clean and fresh.

(Daniel A. Silvestri, Chicago, IL)

I'm an arcade player who'd like to see more home versions of popular coin-op games. However, if a company has licensed the rights to make such a game, it should take the responsibility to insure that it is a good likeness that will satisfy people, because no other company will be able to make it but them. No one is going to accuse a

plants. The quality of the graphics may not be just as good as the arcade version, but it's better than nothing. Atari's **Space Invaders** and **Asteroids** were very good translations, and **Pac-Man** is another one.

(Brenton Garrick, Vallejo, CA)

I have an Atari VCS, and I play it often. Atari's cartridge versions of some popular coin-op games such as **Asteroids**, **Missile Command**, **Space Invaders** and **Pac-Man** are almost as good—if not just as good—as their coin-op cousins.

It's not that I don't like sports games like **Football** or **Baseball**, or adventure

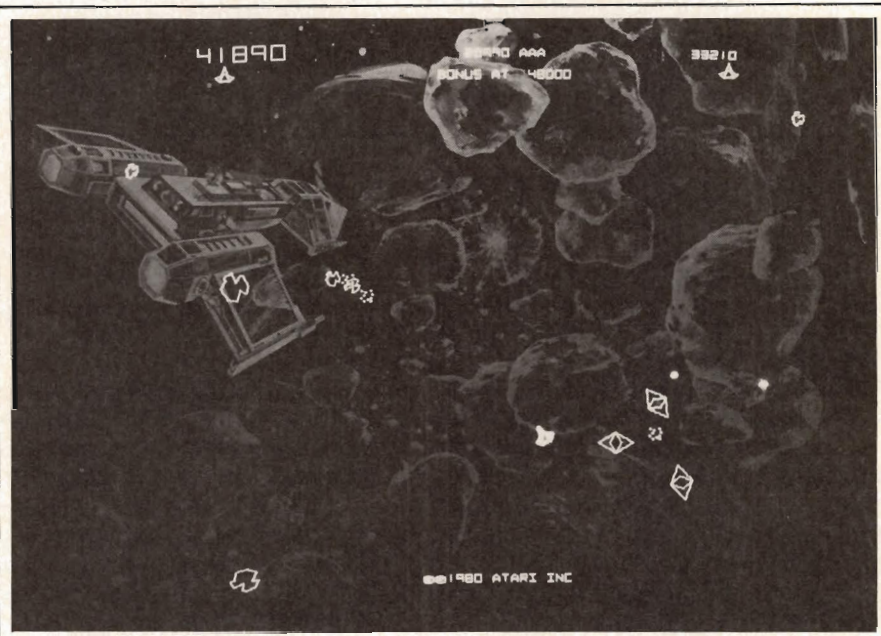

**COIN-OP ASTEROIDS**

company of losing its "creative juices" if it makes a home version too much like the original, because that's what people are expecting.

(Mike Donahue, Rutland, CT)

The arcade game transplants definitely win out over the home market originals. The coin-ops made videogaming as popular as it is today. Games developed just for the home don't hold as long as the coin-op transplants do. While **Pac-Man**, **Asteroids**, etc., just don't compare graphics-wise with the arcade games, they still provide players with a serious challenge.

(Brian S. Johnson, Chicago, IL)

The translation of arcade games for home systems has been exciting to watch. It's fun to see how a coin-op game will be changed—and how it will look—on a home system.

I'd like to see more of such trans-

plants like **Adventure** or **Haunted House**, but I never get to play a coin-op game nearly as much as I'd like to. Even if I did have the time, I don't have nearly enough money to get good at a coin-op game.

It's a lot easier to just walk up to your TV and play a home version of your favorite coin-op game than to spend, say, \$2 on something you're not sure you're going to get any better at. But with my VCS, all I have to do is flip my reset switch. As far as I'm concerned, I'd like nothing better to see every coin-op game on a home videogame cartridge!

(Chris Cope, Central, S.C.)

The idea of translating commercial videogames into software for programmable systems is a good idea but I also think you can get too much of a good thing.

The idea of converting such commercial arcade smashes as **Pac-Man**,



*Asteroids*, *Space Invaders* and *Defender* is great. But the market also needs sports, space and adventure games to go hand in hand with the conversions. The quality of Atari's *Space Invaders* was up to the commercial standard, but *Pac-Man* and *Defender* are a bit of a disappointment.

(Normal Robinovitz, Divide, CO)

### Here's the next "Joystick Jury" topic:

Few arcaders would argue the contention that this is the greatest year for home videogames in the short history of the hobby. New cartridges for all the major systems are not only more numerous than ever before, but include some of the finest electronic games ever produced. Of all the various game cartridges that have reached the retail market since October 1, 1981, which game is your personal favorite—and why?

**Deadline: October 15, 1982**

All you've got to do to participate is follow a few simple rules.

1. Type (or clearly print) your comment on a separate sheet of paper that also includes your name and full address.
2. Keep comments brief and to the point—no more than 100 words.
3. Observe the rules of fairness and courtesy. "Joystick Jury" should be a forum for reasoned opinions, not an arena for name-calling.

Each issue we'll print the most interesting responses to create a symposium on the topic under examination by the jury. The issue's best comment, as judged by the editors of *Electronic Games*, will win a cash prize of \$25. (All submissions become the property of EG, and none can be returned.)

If the tremendous response to *Electronic Games* proves anything, it's that you are an unusually knowledgeable and opinionated bunch. That's good. It means you really care about this hobby and feel strongly about the things that affect it.

Here's your chance to air your views on electronic arcading in front of this magazine's entire readership. "Joystick Jury", a column of reviews by readers, will begin publication next issue. Ⓞ

### POCKET-SIZE VIDEO GAMES



Each game has a microcomputer & liquid crystal video screen to excite you with two levels fast action, sound effects, and score keeping. It's also a clock and alarm. The enclosed battery could last for weeks. All fit into the palm of your hand.

### PERFECT YOUR HEROIC ACT ANYWHERE!

Many games to choose from: **RESCUE, DOLPHINS, CAT & MOUSE, TROJANS, FROGS, TOUCHDOWNS, SPACE SHIELD** and more . . .

\$29.95 each. Shipping & limited 90 days warranty included. Calif. resident add 6.5% tax. Send check or VISA, MASTERCARD No., Expire date, game names & your address to

### *Touch of Rainbow*

P.O. Box 1034 (213) 724-0304  
10345 Lakewood Blvd., Downey, CA 90640

# FANTASTIC PRICES ON VIDEO GAMES

Complete lines of

ATARI	MATTEL
ACTIVISION	COLECO
APOLLO	ASTROCADE
BREAKTHROUGH	VID-TEC
SPECTRAVISION	DATA AGE
20th CENTURY FOX	TIGERVISION
PARKER BROTHERS	IMAGIC

with more to come!!

For Catalogue, Price List and Newsletter with information on ALL New Games send \$1.00 (refundable with first order) along with name and address to:

## NETWORK VIDEO DISTRIBUTORS

P.O. Box P  
Newfield, NJ  
08344

WE PAY SHIPPING

## ATTENTION ATARI 400 & 800 OWNERS! Upgrade



your system with the **SCREEN SONICS™ SIDEWRITER**

"Sidewriter" a modular keyboard that gives 400 owners a full typewriter keyboard, 800 owners can now have an extension keyboard that will allow you to sit back with the "Sidewriter" on your lap and type away.

### HURRY ORDER YOUR "SIDEWRITER" TODAY!

Sidewriters installed complete for \$249.00 (plus shipping)  
Sidewriters for the do-it-yourself owners \$169.00 (conversion kits \$69.00) plus shipping

DEALER INQUIRIES INVITED

FOR MORE INFORMATION

SEND \$1.00 TO: **SCREEN SONICS™ INC.**

14416 S. OUTER 40 RD. • CHESTERFIELD, MO. 63017  
OR CALL (314) 434-0433

Orders outside the United States must be in U.S. currency



# STRATEGY



# SPACE JOCKEY

## Score More Points in These Popular Games:

- ★ Space Jockey
- ★ Yar's Revenge
- ★ Mouskattack

By FRANK TETRO, JR.

### SPACE JOCKEY

Vidtec/Atari VCS

**Space Jockey** is a one-player action game in which the arcader pilots an attack saucer over the earth, attempting to destroy the many different obstacles. Jets, bi-planes, helicopters and even hot air balloons all join the attack against this single craft. Flying close to the ground risks a collision with a house or even a tree. You may also be attacked by a tank now and then.

The saucer is steered by pushing the joystick in the appropriate direction. The button unleashes photon missiles one at a time.

The tanks, jets and bi-planes are worth 100 points each. The helicopters are 50 points, and hitting a tree or

house earns 20 more. You start with three ships and are granted one more for each 1,000 points scored.

The best strategy for this game is to keep your eye on the shooting sequence. The enemy will fire a volley of two shots every four seconds (faster if playing at difficulty "A"). Stay out of the line of fire until the enemy has shot twice, then immediately get in line with an enemy vessel and fire. Do not be too greedy and go for two unless they are right next to one another.

If you are in need of extra men, stay low to the ground and hold down the fire button. This destroys all trees and houses which appear along with my stray tanks. The only flaw in this is that occasionally the tank will get off a shot

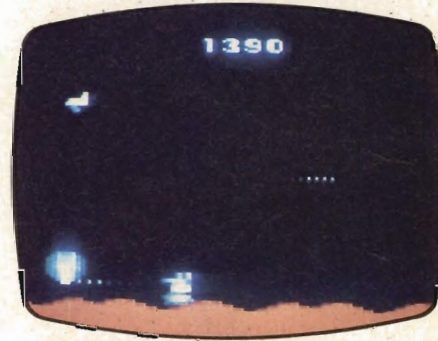
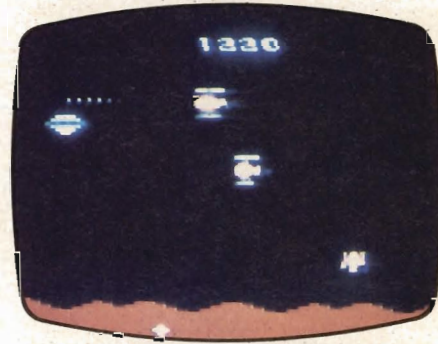

Menaces always approach the player's attack saucer from the right, so it's a good idea to position your craft relatively close to the left edge of the playfield to avoid any little surprises.



before getting incinerated. Should this happen, quickly fly up until the bullet passes. When all is safe, drop back down.

Another thing to remember is that the balloons, trees and houses do not shoot and are easy points. They should be shot whenever possible.

Other game variations on the cartridge allow movement across the entire playfield, instead of being stuck on the left side of the screen. Even with this option, I do not recommend this type of aerial acrobatics as it does not give you enough time to dodge an enemy assault.

Remember to watch those jets, since they are slimmer than all other obstacles and therefore harder to hit.

## YAR'S REVENGE

Atari/Atari VCS

In **Yar's Revenge**, the Yar fly must protect its planet from the relentless attack of the dreaded Quotile.

The Quotile is protected by a force shield which takes the shape of either a semi-circle which shields his front, or a spiraling rectangle that covers him altogether. You must blow a hole in the shield and then fire the powerful Zorlon cannon through it to destroy the Quotile.

The Yar is equipped with an energy laser that wears away the shield when fired. He may also deal with the shield by actually pressing against it and eating his way in. Once a hole is cleared, the Yar activates his Zorlon cannon by either touching the Quotile, or by eating a piece of the shield. The cannon appears at the left and can be fired once, using the fire button. Once fired, the button will resume firing energy lasers until the cannon is reactivated.

The Quotile is no pushover, however. Periodically, he changes into a deadly swirl and comes barreling after you. If you hit the swirl with the Zorlon cannon, you destroy it and the Quotile and score bonus points. There is also a homing missile which follows your every move and tries to ram. The neutral zone in the center of the screen is used for protection against the homing missile. Too bad it won't stop the Swirl!!!

Once the game starts, the Quotile will appear behind his moving shield at the right. Move in and fire as quickly as possible, for he will change into a Swirl about five seconds after the start of each round. A warning noise blares and the Swirl replaces the Quotile. If you wish to simply avoid it, stay on the

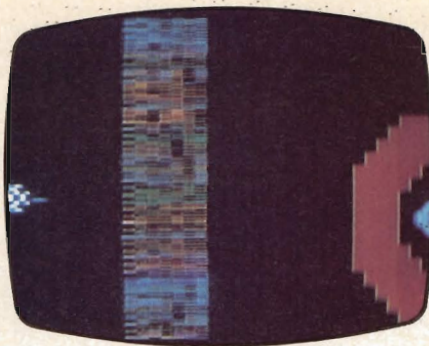

YAR'S REVENGE

move! Travel vertically, scrolling off one side and back on the other. Hopefully, this will not give the Swirl a chance to home in on you, and it will just fire wildly.

If you intend to destroy the Swirl, you must eat a shield cell and activate the Zorlon cannon. Then fly just to the left of the neutral zone. Don't touch it, because you can't fire while inside. Position yourself just to the left at either the very top or bottom. Once the swirl appears, don't move. Let him home in on you. Once he fires, scroll off the side you were positioned next to. You must move quickly or your own shot will destroy you. If done right, the scrolling should throw the Swirl off. He'll run right over to where you were, just in time to get shot.

The homing missile may also be dealt with in two ways. It can be shot with the Zorlon cannon, but this only produces another one. The best thing

to do is just avoid it. Use the scrolling to best advantage, since the missile cannot scroll and must travel the length of the screen to catch you. You can also use the neutral zone, but you can't fire while in there. Once the Quotile is destroyed the first time, an explosion will occur. The next Quotile will be protected by a rectangular shield. This is more difficult to destroy, since the constant swirling does not allow a hole to form for too long. Be quick.

Also remember that eating a cell is worth substantially more than shooting one, so eat whenever possible.

## MOUSKATTACK

On-Line Systems

**Mouskattack** turns the arcader into Barry Bain, ace plumber, and sends him into the dangerous tunnels of Rat Alley. The mission: to install pipes on the entire level and escape alive.

The plumber lays the pipes and joints by moving through the maze. The gamer controls him with the joystick. Trying to stop the plumber are three rather scruffy-looking rats which devour on contact. After finishing a level, you go on to another section of Rat Alley which features faster rats. The game lasts three lives and awards one extra life for each two levels completed.

Two objects help

## MOUSKATTACK

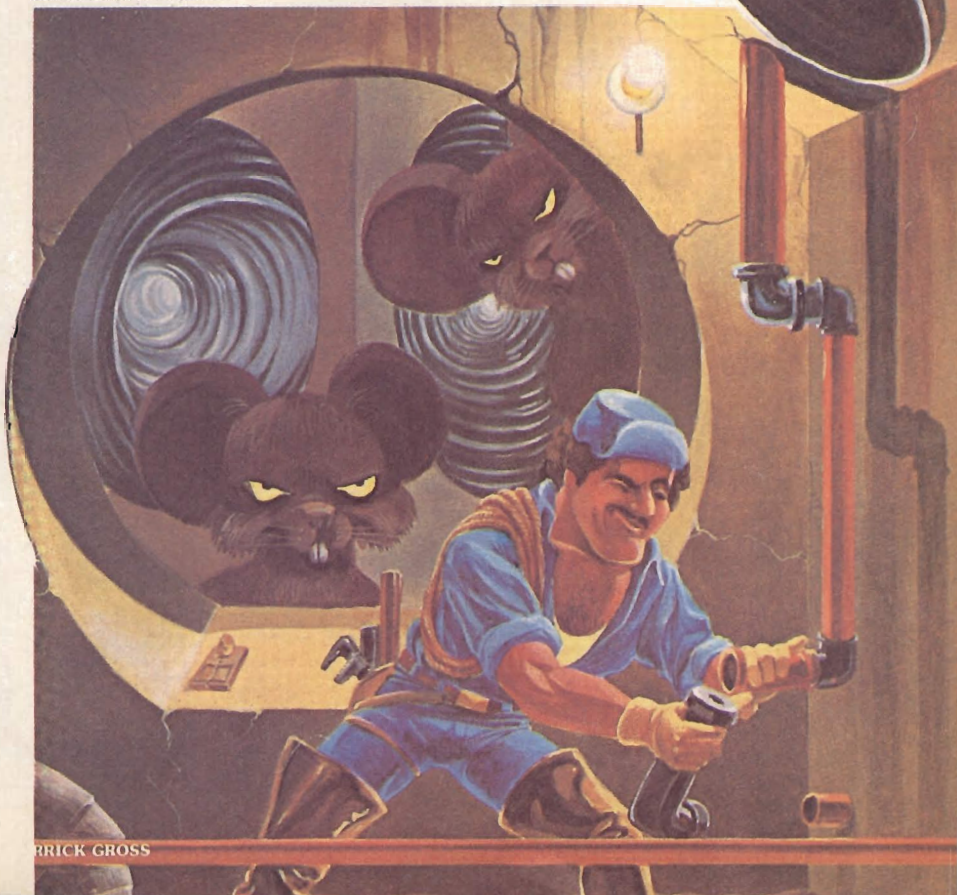



in the mission. The first is a set of traps which appear toward the right of the center block. Pick these up by pushing the button while walking over one, and drop it by pushing the button again. When one or more rats are tailing you, set the trap and keep going. If all goes well, the rats will get stuck. At this point, turn around and run back over them. This, in effect, hits them over the head with a pipe and kills them! The program awards 200 points if one rat was in the trap, 400 for two, and 800 if you get all three. The rats are strong, though, and they will bust out of a trap after a few seconds, so be quick.

The other weapon is the frightened felines. These two cats can be picked up in the same way as the traps. When the rats come close to catching you, drop the cat. This frightens the rats and forces them to change directions. Alas, all that glitters isn't gold, for if the red Super Rat runs into your cat, he'll eat the tabby whole!

Each section of laid pipe is worth 10 points. Periodically, you will lay a bad connection in your hurry. If this happens, the plumber must run over it again to fix it. It's impossible to move to the next alley unless all connections

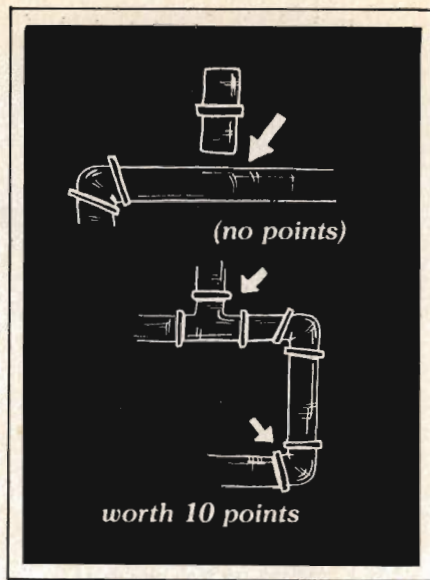

CONNECTING JOINTS

are clean and the maze is filled.

Once the game begins, run right for a trap and grab it. Try to head for the corners and complete them first since they're the hardest. Never enter a corner without either a trap or a cat, or you're asking for trouble. You're likely to get it, too.

Because Barry Bain can only carry one item at a time, you must decide

whether to go with a trap or a cat. If a super rat is present (which randomly occurs based on how many rats are killed), a trap for it will snare Super Rat. If no super rats are present, then a cat is fine.

This game features an escape tunnel like **Pac-Man**, except that it runs up and down. This tunnel, when exited from the top, will bring you back on the bottom and vice versa. Any rats traveling through are cut to half-speed. Learning to use this tunnel comes in very handy . . .

Don't worry about using all the traps or killing off the cats, since they are periodically replaced. Once one appears, you must pick it up quickly, or it will vanish again.

Many times during a game you will run over what you think is the last bad connection, yet the game won't end. This is because there is still another bad pipe which is probably almost impossible to find. If this occurs, don't move around looking for it, while taking a chance of getting eaten. Simply push the space bar on the computer. This freezes the game and gives you time to find the faulty connection. Once you do, just push the bar again and fix it.

Never lay a trap near the entrances to the rat house. This may sound like a good idea, for once a rat comes out it will be instantly trapped. In reality, once you eat that rat another will instantly spring from the house. If you're standing right there, it's curtains . . .

Remember that the pink rat is the fastest, orange second, and blue is the slowest. Orange and blue are usually either slower than the plumber or, at most, move just as fast. Pink, however, is faster than you and will gain on you. If he begins tailing you, quickly head for a trap, a cat or the tunnel, or he will catch you. If you eat the orange or blue rat, and a super rat appears in his place, Super Rat travels just as fast as the pink rat. This means that now there will be two rats which are faster than you! This is where the trap comes in. Try to trap and kill Super Rat so he will turn back to his normal, hopefully slower, color.

But please, whatever you do, do not forget the coward's way out! You can ignore the stupid rats altogether, set down your pipeline and when one of the ordinary vermin gets a bit too close, just take a couple of quick turns and *voila!*, you'll lose him just like that!

After all, killing the regular rats just makes Super Rat angry.

1982 >>>

L=0000320 S=000000  
 EMS=10 M=37 S=61hg

# AIRSTRIKE

**NEW! AIRSTRIKE FOR THE ATARI 400/800 16K**

- INTRODUCING THE NEW ARCADE-STYLE GAME FOR ATARI COMPUTERS!
- SUPERB FINE SCROLLING GRAPHICS AND DAZZLING ARRAY OF COLOUR.
- FIGHT YOUR WAY THROUGH CAVERNS AND TUNNELS WITH ATTACKING MISSILES. FUEL AND AMMO DUMPS TO CONTEND WITH!
- 100% MACHINE CODE PROGRAM FOR ONE OR TWO PLAYERS.
- MULTIPLE SKILL LEVELS.

AVAILABLE NOW ON 16 K CASSETTE: \$39.95  
 AT YOUR LOCAL DEALER-ASK FOR A DEMONSTRATION  
 ATARI IS A T.M. OF ATARI INC.

**ENGLISH SOFTWARE COMPANY**  
 P.O. BOX 3185 REDONDO BEACH, CALIFORNIA 90277



# GROW WITH US!

A special message for electronic games retailers

Playing electronic games is now America's fastest-growing hobby. Here are some facts:

★ More than 10 million quarters are dropped into current coin-op champ "Pac-Man" every single day.

★ Nearly 5 million programmable videogame systems are hooked up to U.S. TVs already. Four million more are expected to be sold this year alone, along with 30 million game cartridges to play on them.

★ Sales of computer games are expected to exceed 1 million units by the end of the year.

ELECTRONIC GAMES, the first—and only—magazine devoted to this booming field, is growing as fast as the high-tech hobby it covers. Our premier issue was a newsstand phenomenon, with many dealers reporting sell-outs. Our second issue promises more of the same.

So if you sell videogame systems, hand-held games, or computer games, you should also be selling ELECTRONIC GAMES Magazine. As an EG retailer, you'll earn a good profit on every copy you sell (of course, all unsold copies are fully returnable). You'll also be providing your customers with that special "extra" that will bring them back to your store again and again.

To get all the information you need to join the ELECTRONIC GAMES retailer program, fill out and mail the coupon below. There's no obligation, so do it today. ELECTRONIC GAMES Magazine is growing fast . . . and we cordially invite you to grow with us.

Mail to: **ELECTRONIC GAMES**  
Retailer Program  
235 Park Avenue South  
New York, NY 10003

**YES, send me information on the ELECTRONIC GAMES retailer program.**

My Name \_\_\_\_\_

Store Name \_\_\_\_\_

Store Address \_\_\_\_\_

City \_\_\_\_\_

State \_\_\_\_\_ Zip \_\_\_\_\_

My Position/Title \_\_\_\_\_

EG10

## FingerTip Controller for the Atari®



\$19.95

Works with all games that use a joystick

Direct from the manufacturer

**KY ENTERPRISES**

195 Claremont, #288, Long Beach, CA 90803

(213) 433-5244

Available in kit form—\$14.95.  
Shipping charge \$3. Calif. residents add \$1.30 tax.

- 5 responsive arcade-quality durable buttons for 4 directions & "fire"
- Faster direction changes
- Rapid firing improves scores
- 2 year warantee
- 30-day moneyback guarantee
- Left-hand models available
- Attaches to top of video game console

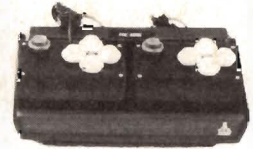

Controllers for handicapped also available. Write for information.

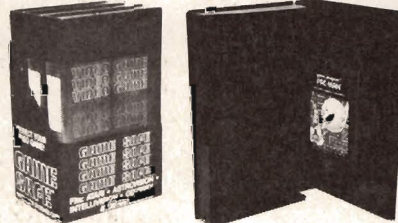

## GAME SAFE™

The Safest Place For Your Video Games!

Attractive protection for your expensive video game collection.

Interior sleeve holds instructions and overlays — prevents loss and damage!

**UNIVERSAL! Fits**

- ATARI™ • ASTROCADE™
- ODYSSEY™ • INTELLIVISION™ and others!

**TOTAL VIDEO SUPPLY**

**TVS**

The Leader In Consumer Video Accessories

9181 Kearny Villa Court • San Diego, California 92123 • (714) 560-5616

MAZZE & SIMEONE PRODUCTIONS INC. PRESENTS

# THE VIDEO & ELECTRONIC GAMES SHOW

Thursday • Friday • Saturday • Sunday

October 28, 29, 30 & 31 - 1982

Info. (516) 541-3078/541-3079

NASSAU VETERANS  MEMORIAL COLISEUM



# ARCADE



## Journey to a California Game Palace

**S**tanding on a pier at the approach of evening, sun setting in a blaze of color, no true arcader's heart could keep from swelling at the sight of the vision standing proudly across the waterway. Perhaps the most scenic arcade in America, Redwood City's Castle Golf and Games is an actual *castle*, complete with all the mock-medieval

enchantment the electronic gamer with a romantic soul could hope for.

Part of the Golf and Games arcade chain (a collection of family-oriented game fortresses owned by the Malibu Grand Prix), the Redwood City castle fantasy land is located on five acres just off Highway 101 in California. There's a wide range of entertainment available in addition to the 80 videogames, including miniature golf, 15 pins, bumper boats, batting cages and 15 skeeball machines.

It has everything from golf to **Gorf**, and there's more to come! The unit is

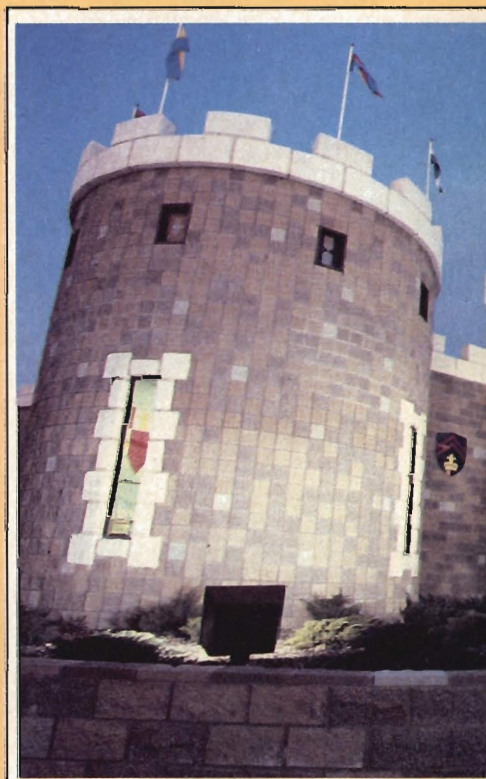



# AMERICA

By DAVID LUSTIG



still spacious, with room for lots more electronic entertainment, all waiting for someone to turn on the electricity.

"We're not electrically set up for many more games than we have right now. We removed 30 games and replaced them with picnic tables," explains assistant manager, Diana Erber. The fun center recently added a pizza stand.

Favorite games vary from hour to hour at Redwood's game castle. Teens jam the place on Friday nights with **Defender** and the familiar science fiction games getting the heaviest play. Saturday and Sunday mornings, on the other hand, Golf and Games becomes a true "family fun center", as they refer to themselves in an attempt to avoid the less savory connotations of the word "arcade". The crowd is predominantly parents and young kids on the weekend morns, with titles like **Pac-Man**, **Ms. Pac-Man** and **Frogger** drawing the traffic.

Redwood City's Castle Golf and Games gives its customers something

more than just **Donkey Kong**, **Zaxxon**, **Robotron** and **Hyperball**; it has *atmosphere*, an ambiance of luxury and scenic beauty that elevates the entire arcade experience. **Solar Fox**, after all, is the same game whether it's played in the back of a laundromat or in a palace. The enjoyment one derives, however, is vastly different.

As the gap between coin-op videogames and the home product narrows dramatically, the fun centers must offer the player something extra in order to prosper. Despite the fact that the home and commercial markets actually help one another—the arcades must offer both superior games, and a desirable environment in which to play them. The arcade itself must become a greater and greater part of the *attraction*, rather than simply a place to be endured while playing all those fantastic games.

Redwood City's Castle Golf and Games serves as a convincing argument for that point of view.

Ⓔ







By CHARLENE KOMAR

*Ken Uston's Guide to Buying and Beating the Home Video Games* (Signet, \$3.95) is a big, thick book designed to cover the entire home video field. It's a formidable task, but the book does a creditable job. Atari, Intellivision, Odyssey<sup>2</sup>, Astrocade and Fairchild Channel F are all included, and more than 180 cartridges get space.

After a very brief note to the reader,

the book gets down to business. First, the systems themselves are dealt with. Each is discussed in terms of general information, the console, consumer tips, controls and the author's experience with the system—obviously, a very complete offering.

That part is strictly informational; the systems and games are compared in the next segment. Systems are di-

vided into the games currently available, game potential, controls, the control system, reliability of operation, console durability and appearance, cartridge containers, price and a summary. There's also a table rating the systems on a point basis.

The comparison of the games consists of a total of 12 points covering the industry in general and the various manufacturers. Finally, a chart evaluates the games, grouping them by the system.

The bulk of the book is devoted to the cartridges. Separated by manufacturer, each features an introduction that talks about the system's games in general. It discusses quantity, degree of interest, versatility, hand-eye coordination, mental challenge, interest and the number of players.

Each individual game is then covered. In each case, the game is first evaluated. Then, its basic objective, scenario, board and controls are presented. Facts you should know and strategies round out the sections.

In some cases, a board diagram is featured. Generally, though, the volume is light on illustrations; the emphasis is on written explanation.

The book concludes with a chapter on new products and information.

The volume is obviously ideal for those who have decided to buy a home system, but are confused about which to get. It can also serve as a handy reference book and memory-jogger for those already heavily into home systems. Uston's very readable style is a delight, and the adherence to formats makes comparisons easy. All in all, a worthwhile addition to a game library.

*How to Win at Donkey Kong* (by the Editors of Consumer Guide, Pocket Books, \$1.95) is a 32-page guide to saving yon fair maiden from Donkey Kong's clutches. Despite its slim size, the volume does a competent job of covering both game strategy and the game in general.

To start, the book provides an explanation of the name and a run-down on the action. The Cast of Characters includes a rather lengthy description of each of the three leading players in this melodrama, as well as the recurring factors like ladders, barrels and fireballs.

An overview of the *Donkey Kong* strategy makes an important point that perhaps could be more strongly emphasized: the most basic skills must be

— For the Serious Electronic Gamer —

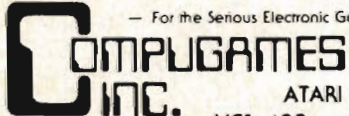

**ATARI**  
VCS, 400 and 800,  
APPLE, INTELLIVISION, TRS,  
ODYSSEY, BALLY, PET  
and more at VERY LOW prices

We carry full lines of  
Game Computers, Cartridges,  
Storage Cases, Cassette and  
Disk Games, Joysticks and other  
game accessories all Near Wholesale!

Join **COMPUGAMERS CLUB**. Take advantage of  
Greater Discounts and Freebies. Details in catalog

Allow 2 Weeks Photocopied Coupon Accepted

**30 DAY - 100% GUARANTEE**  
On All Items

Clip this ad and mail along with  
\$2.00 for Catalog and Price Lists.  
You'll be glad you did!!!

NAME \_\_\_\_\_

STREET \_\_\_\_\_

CITY \_\_\_\_\_ STATE \_\_\_\_\_

ZIP \_\_\_\_\_

Mail To:  
**COMPUGAMES, INC.**  
Catalog Dept.  
P.O. Box 190  
Enfield, CT 06082

Check or M/D only C 2

WANTED!

WE BUY

Used ATARI  
and ACTIVISION  
Cartridges



Send Self Addressed Stamped  
Envelope for Buying Price List.

Forest Hills Discount Books  
63-56 108th Street Forest Hills NY 11375



well-learned before one can make full use of the suggestions in this booklet. If you haven't mastered climbing ladders, jumping barrels and on and off elevators, broad jumping gaps and grabbing the hammer, following the well-thought-out suggestions to come won't help you save Donkey's Fay Wray.

Another point well-made is there is a randomness involved in this game. The patterns, although generally reliable, are not fool-proof, and to be a true expert one must be able to handle the unexpected barrel or a foxfire gone haywire. After all, faint heart ne'er won fair maiden.

The actual patterns, each facing an illustration, take about 14 pages. The second "Ziggurat Pattern" is really nearly the same as the first, as the authors admit. But the tips are solid and worthwhile.

Pages on various types of "finesse" round out the book. The efficiency of this set-up is debatable; some readers might prefer having all suggestions grouped under the patterns for quick and easy reference.

"Donkey Kong Grandstanding" is a nice touch, a compilation of tricks, like the Back Jump, that Mario will perform if you know how to persuade him. Unfortunately, in the first printing, an error left the instructions for the Knee Drop incomplete.

A spokeswoman for Pocket Books said the problem would be corrected in future editions. However, for those now vainly trying to learn the maneuver, a letter to Pocket Books, addressed to the Editorial Department, will produce the needed information.

The volume is very colorful, with neither too many or too few diagrams. It probably will suit beginners best, considering the rather detailed character descriptions and the emphasis on basic instructions.

The relatively simple tips, light style and easy-to-follow information are pluses for the book. However, don't look for any great depth—*Donkey Kong* players looking for a volume geared to the already good player should seek elsewhere.

Despite that, a few basics have been missed. An explanation of such matters as how many plays for your quarter and similar elementary facets might have been appreciated. But on the whole, for the comparatively low price tag, this book is recommended for those who are just meeting that crazy gorilla!

# MOVING?

Don't risk missing an issue of **ELECTRONIC GAMES**. If you're planning on changing your address, please give us 8 weeks notice. Simply write in your new address below and mail this coupon—ALONG WITH YOUR SUBSCRIPTION MAILING LABEL—to: **Electronic Games** Subscriber Services P.O. Box 1128, Dover, NJ 07801

(please print)  
 Name .....  
 Address .....  
 City ..... State ..... Zip .....

## ATARI™ 400/800 OWNERS!

Discover

## DATAPORT

YOUR SOURCE FOR THE BEST IN ENTERTAINMENT AND EDUCATIONAL SOFTWARE! OUR NEW CATALOG LISTS PAGE AFTER PAGE OF GAMES ON BOTH CASSETTE AND DISK! SEND \$1.00 NOW TO:

**DATAPORT**  
 P.O. BOX 975  
 NORTHBROOK, IL 60062

### YOU'RE NOT GOING TO BELIEVE—

**OUR LOW-LOW PRICES ON VIDEO GAMES, CARTRIDGES, COMPUTERS + ACCESSORIES**

**ATARI™ • ACTIVISION™ • APOLLO™ • IMAGIC™ • COLECO™ • MATTEL™**

**U.S. GAMES™ (VIDTEC™) • BREAKTHROUGH™ ODYSSEY™ • & MORE!!!**

**MOST ORDERS SHIPPED FOLLOWING DAY RECEIVED!!! SEND 25¢ FOR COMPLETE PRICE LISTS**

**MAXARON HOME ENTERTAINMENT**  
**22932 VAN DYKE, WARREN, MI 48089**  
**(313) 758-7884**      **MASTERCARD / VISA**  
**• OPEN 7 DAYS •**

Play **MORE ATARI VCS** and **ACTIVISION** Game Cartridges

*without buying them. Join the VID-CART LIBRARY™ EXCHANGE PLAN! For ONLY \$5.75 exchange a cartridge you're tired of for one you'd like to play. We'll even give you a cartridge of your choice to get you started. Enjoy bonus exchanges and special offers too! All this for a one-time membership of ONLY \$35.00. •• Act Today •••• Tell Your Friends •••• Clip or Copy Coupon ••*

Membership Coupon Enclosed is \$35.00 for my VID-CART LIBRARY Membership.

— VISA or — Mastercard — Check — Money Order

Please send me my initial cartridge at no extra cost.

Acct#: \_\_\_\_\_  
 Exp. Date: \_\_\_\_\_  
 Signature: \_\_\_\_\_  
 Name: \_\_\_\_\_  
 Address: \_\_\_\_\_  
 City: \_\_\_\_\_  
 State: \_\_\_\_\_ Zip: \_\_\_\_\_

**Choice**  
 1st \_\_\_\_\_  
 2nd \_\_\_\_\_  
 3rd \_\_\_\_\_

Allow 2-3 weeks for delivery.

Satisfaction Guaranteed

Mail to: VID-CART LIBRARY, Dept. A, Box 807, Framingham, MA, 01701.



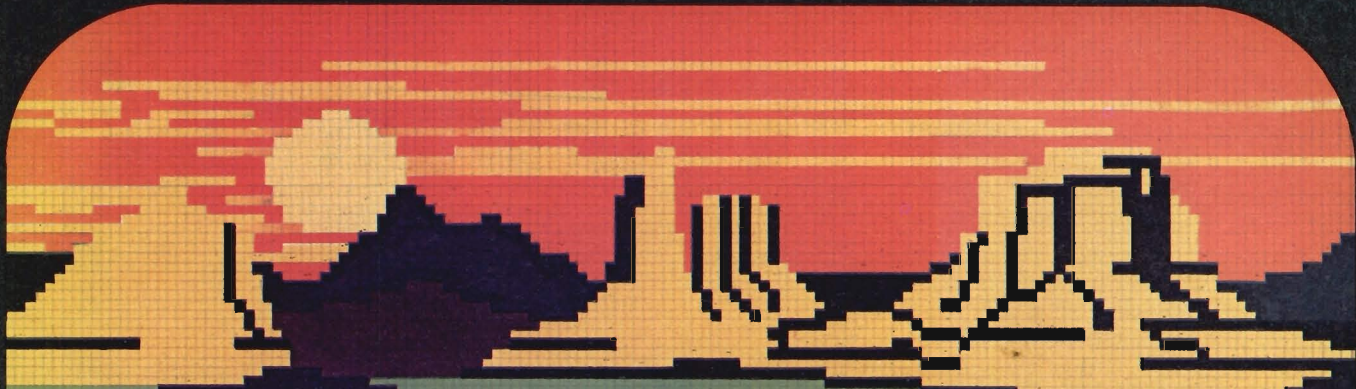

# It's Dramatic! It's New! It's for Southpaws too!



Player is the Blaster with full screen access and 180° direction change. Dual controls for right or left hand firing.

Fast action on a full color monitor with constant peril from giant snakes, pterodactyls, mutant gorillas and dense vegetation.

The attack starts with a few snakes as Slither Bonus winds down. When player zaps all snakes, he gets remaining bonus points. Now, additional snakes attack in waves. Every time Slither Bonus reaches zero new snakes of a different color launch another attack.

As player concentrates on snakes, pterodactyls and mutant gorillas flit across the screen to increase danger and challenge. Additional points are scored by



blasting these intruders... the closer they are downed to the blaster, the higher the score.

The gorilla places additional vegetation on the screen to further tax player who must now blast through the grass.

As player's score mounts, snakes get mad. Crafty! They now chase the player's blaster which must be maneuvered with great skill to avoid the attack.

The gorillas make further excitement for the player... when they touch a snake, it becomes invisible, and only the eyes show on the screen.

When snakes are hit, they turn into grass, making things even more difficult for the player. The longer he holds off their attack, the higher his score.







# COIN-OP CLASSROOM

## Making a Monkey Out of Donkey Kong

By BILL HEINEMAN

**T**he circus is in town! Step right up and enjoy the animals and the clowns. Why, you could even see the dumbest monkey in captivity; he is so dumb that a donkey would turn down his I.Q.

A bunch of folks from Japan named him "Donkey Kong" because of his overall stupidity and the fact that he likes to watch *King Kong* reruns on T.V. every chance he gets. The huge ape's obsession with the movie *King Kong* made him go wild a few months back. It all started when the circus came into Chicago. The tent was still going up when that cursed movie came on the late show. That's when the dumb ape then began living out the part of King Kong.

First of all, he broke the bars of his cage with his bare hands and began running to a building next door that was under construction. Several crewmen saw the ape break out and summoned the police, while a few others began to chase the kooky gorilla.

A man named Mario and his girlfriend Cindy were sitting at a bus stop when all this commotion was taking place. Mario told Cindy to stay where she was so that he could see what's going on. No sooner did he

leave than Donkey Kong reached the base of the unfinished building. The gigantic monkey stopped dead in his tracks. He'd forgot to get a beautiful girl to hold hostage! The ape ran to the fence that surrounds the building and jumped over. Looking around, he spied Cindy conveniently seated on a beach right in front of him. Kong carried her off to the building, her screams filling the air.

Mario, hearing his girlfriend's cries, immediately returned to the bus stop, just in time to see Cindy hauled over the fence. Mario then ran toward the main entrance of the construction yard only to discover that all the workmen had been scared off when the gorilla made his first appearance. Mario looked up to see the gorilla reaching the top and placing the girl on a small perch slightly above himself.

Then the ape looked down to see Mario running toward the bottom of the structure. Jumping up and down with rage, Kong made the scaffold buckle and bend into a weird shape, but that didn't stop Mario from reaching the oil can at the bottom.

Kong checked his perch for a weapon and only found a large number of barrels full of nails and tar. Kong grabbed a blue tar barrel and

hurled it at Mario. Mario sees this missile coming at him and begins to run to the right. The barrel moves to the right with Mario, traveling at a slightly faster speed. Mario leaps to slow himself down a little, but the barrel is now directly overhead so Mario leaps a second time to put the barrel just above and ahead of him. The instant the barrel lands in front of Mario, he makes a heroic leap over the barrel and runs to the ladder at the extreme right.

Climbing the ladder in record time, this brave carpenter leaped over a barrel of nails to find yet another barrel heading his way. It was at this moment that the strangest thing happened. When the barrel of tar reached the bottom of the tower it rolled right into

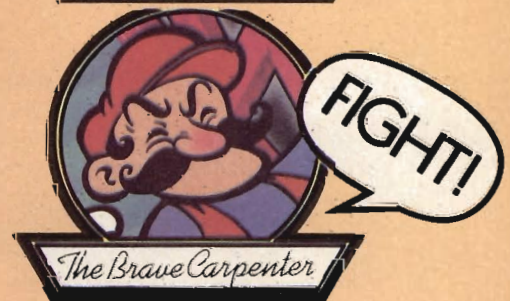

the oil can placed there. The can exploded and a little fire monster emerged. This critter then began to roam at will, completely unaffected by rolling barrels or fire. No one has been able to explain the creature's existence other than to say that it was there.

While on the second floor, Mario stopped at the first ladder that he came to and stood to the left of it. When the coast was clear he climbed the ladder and moved to the right, stopping at the



first ladder he reached. This time, he waited to the right of it. When the coast was clear again, Mario proceeded to the fourth floor and ran to the left-most ladder, leaping over any and all barrels that came his way. Standing at the left-most corner of the fourth floor, Mario waited for the first opportunity to climb the ladder safely.

Then the carpenter discovered a hammer left by one of the workmen hanging just above his reach. Our hero jumped and grabbed the hammer and began to pound the ground. Any barrel hit by this hammer simply disintegrated. However, the hammer wasn't designed for barrel mashing so it broke apart after about 10 seconds.

Mario saw that the barrel-mashing was taking its toll on the poor hammer, so he began to slowly move toward the right, making sure to squash any barrel in his way. When Mario reached the right-most corner, he learned that he could swing the hammer high enough to destroy any barrels directly above him. It was at this moment that the hammer reached the 91st day of its 90-day warranty. Once the hammer broke, Mario started to jump up and down in his corner so any barrel falling from the sixth floor onto the fifth wouldn't squish him. When the coast was clear, he ran for the ladder to the sixth floor. He ran and jumped, ran and jumped until he got to the last ladder. Jumping a last barrel for luck, he climbed up to rescue Cindy.

Donkey Kong was enraged. Ascending a short ladder he snatched the girl away from Mario. The big gorilla then rose out of sight up the scaffold.

Kong made it to the top of the conveyor belt system and put the girl on another small pedestal to keep her confined. Mario climbed to the bottom of the system and ran to the nearest ladder. It was at this very moment that more of those little fire monsters made their debut. In the center of the conveyor system, a large oil can had burst into flames, and when Mario appeared at the bottom, those little creeps began emerging and chasing the little man everywhere. Mario, seeing that he was in big trouble, climbed the first ladder and moved to the right: as far as he could go without falling over the edge. When he reached the edge, Mario leaped over the extra wide chasm to the only ladder on the other side.

Mario then looked up to see if any coal pans were riding the belt above. When there were no coals above, Mario climbed the ladder and began to climb the last ladder. Halfway up

though, the ladder began to retract so that Mario couldn't get to the top. Mario had no choice but to wait and hope that one of those fire monsters didn't turn him crispy. After a three-second wait, the ladder extended so that Mario could climb to the top immediately. Kong, seeing Mario, grabbed the girl and climbed another ladder in hopes of ditching Mario.

When Mario followed Kong to level three, he found that Kong had destroyed much of the scaffolding around the elevators. Two fire monsters trapped on sections of the



DONKEY KONG COIN-OP

badly mangled scaffold were very eager to bake an unsuspecting Mario. The hero jumped onto an elevator that was going up and then hopped back to pick up an umbrella. Mario then went down two ladders to get back to where he started. Mario returned to the elevator and, seeing the monster on the top of the center scaffold, leaped off the elevator, leaving a medium width chasm.

Upon landing, the carpenter picked up what looked like a lawnmower and waited until the monster came down one of the two ladders. When the monster used the left ladder, Mario went up the right. Mario reached the top of this section and hailed the

down elevator. Mario sailed over the first and largest chasm because it was the fastest way to get to the girl. Mario's heroic leap cleared the chasm by inches.

Mario then used the only ladder to get to the top. The last passage was guarded by jackhammers that have gone wild.

Mario timed himself so the instant that a jackhammer bounced overhead, our hero made a mad dash to a point just above the down-elevator. Mario then about-faced and timed himself again to make a dash to the ladder that would take him to his sweetheart. Running as fast as his feet could carry him, Mario sped to the ladder and rejoined Cindy.

Kong couldn't believe the persistence shown by Mario in his bid to get the girl away from him. Once more, Kong grabbed the girl and headed for the absolute top of the building. This further enraged Mario and made him even more determined to end this chase once and for all.

Mario climbed up to the bottom of the structure. He ran to the left for the ladder that could be found there. After climbing the ladder, Mario noticed that five fire monsters had appeared on the right side of the structure. So Mario ran to the right and pulled out a bolt that was holding the structure together. He climbed the closest ladder to the third floor. When he got there, Mario scurried to the left and pulled out a second bolt, while continuing to run to the left. After using the left-most ladder, he ran to the right to pull out that bolt.

Mario then climbed to the top and pulled out the left bolt on the top floor. Mario then stayed on the left side of the tower and went down to the level just below him. Waiting for the right time, he jumped the chasm to get the hammer hanging from the center of the fourth floor. Using this weapon, he mashed any fire monster that dared to come near while staying on the right-most side of the building. He knew that if any more monsters appeared, they would show up on the left side and be cut off by the small holes in the floor.

By making some daring maneuvers, Mario finally pulled out the last bolt.

The entire tower began to shake and crack. Kong hung in mid-air for a second, banging on his chest as a sign of defiance, then fell flat on his head knocking himself unconscious. Mario, with Cindy at his side, ran far away from the scene of the crime never to be heard from again.



# 9 COMMAVID™

Presents

## PLAYABLE VIDEO GAMES for your Atari® Video Computer System™

CommaVid video games are designed to keep you involved. New games where your pleasure increases as your skills develop. More than just flashy graphics, you'll find challenges that hold your interest play after play.

### THE REVIEWERS REPORT:

"...it's always nice to see companies trying out new ideas. Cosmic Swarm is a darn good one."  
*Electronic Games, August '82*

"Cosmic Swarm... has ingenious play mechanics... suitable for long gaming sessions."  
*Video Magazine, July '82*

Play for your self! Fight off the attacking alien termites before they jam your space station.



### OTHER VIDEO GAMES FROM COMMAVID:

#### ROOM OF DOOM™

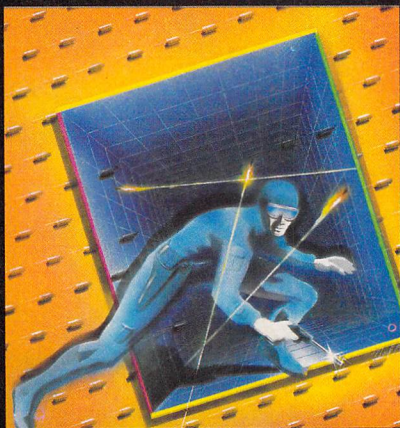

Can you escape from the gunmen trying to annihilate you?

#### MINES OF MINOS™

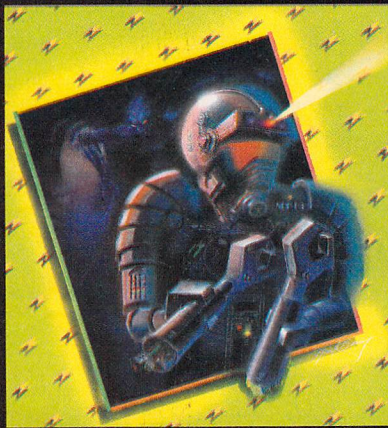

Aliens stalk the corridors. A single robot survives to battle them.

#### MISSION OMEGA™

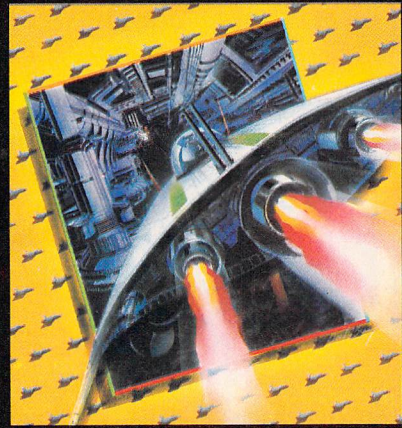

The last mission from earth, and only you can save the universe.

**CommaVid Inc., Box 3308, Fox Valley Center, Aurora, IL 60505**

Atari® and Video Computer System™ are trademarks of Atari, Inc.



# NEW PRODUCTS

## PAC-MAN LIGHTER

*Scripto/Suggested retail price—\$1.99*

He started out life humbly enough, just a sideways-smiled face with a winning grin and an appetite that just wouldn't quit. He's since spawned a female counterpart, T-shirts, towels and even a Pac-Baby. He is, of course, our friend the **Pac-Man Gobbler** and now he'll be able to light your fire far more literally than any

previously arcade-spawned character—via the *Pac-Man* lighter from Scripto.

The butane flame-maker with the familiar *Pac-Man* logo is being licensed from Midway exclusively by the Atlanta, GA, manufacturer as part of its popular "Star Lights" line which has previously featured such rock and pop musical personalities as The Who, Black Sabbath, The Police and J. Geils Band.





**GAME SAFE**

*Total Video Supply/No price available*

Although numerous manufacturers are producing storage racks for videogame cartridges, the Game Safe, from Total Video, is the first single-cartridge storage box. Capable of holding any Atari VCS, Intellivision, Odyssey or Astrocade-compatible cartridge, the case, dubbed the TA-200, is constructed of impact-resistant plastic, features a push-button security lock and an inside sleeve to store instruction booklets and controller overlays.

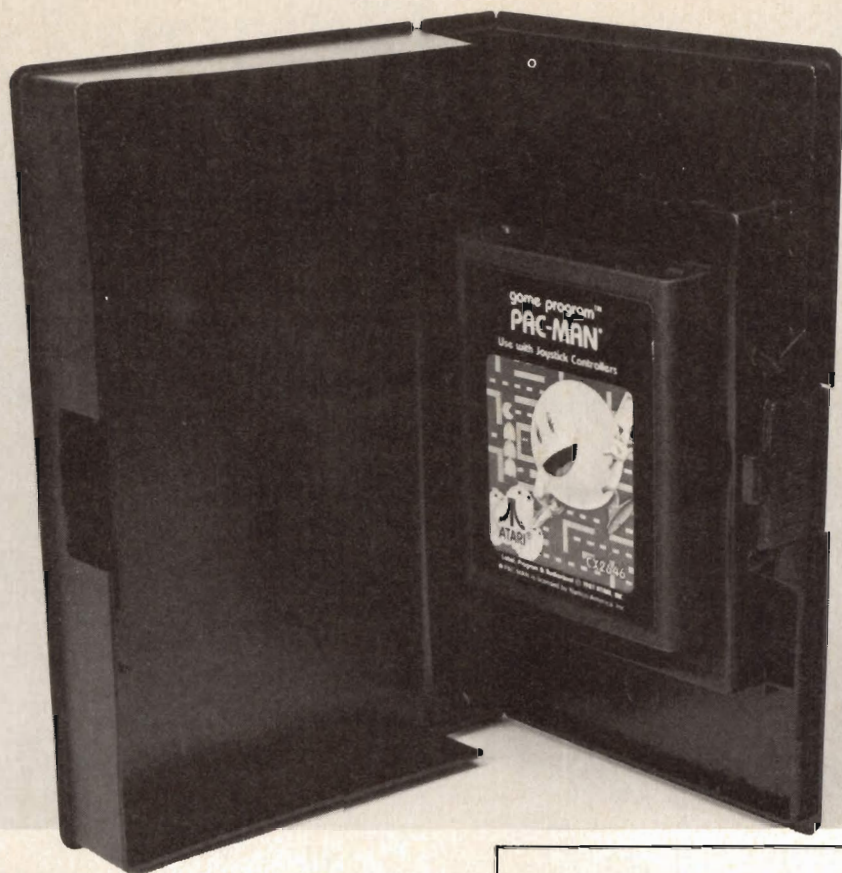

**STICK STAND WITH FASTBALL KNOB**

*K-Byte/No price available*

For those more down-to-earth gamers who enjoy playing Pac-Man from a ground-based, stationary game stand, K-Byte has their new Stick Stand, a hollowed base into which the joystick is inserted.

The kit even comes with a special "Fastball" knob-control for an easy joystick-type grip.



JOYSTICK STAND



SNAP FASTBALL™ ON JOYSTICK

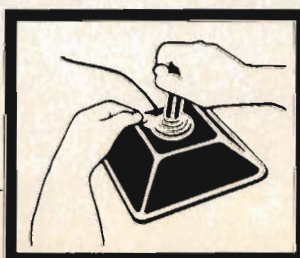

I plan on living a long and healthy life, so I get regular cancer checkups. You should too. Contact your local ACS office for a free pamphlet on our new cancer checkup guidelines. Because if you're like me, you want to live long enough to do it all.

American Cancer Society





If you're really into electronic games—a safe assumption since you're reading this magazine—you'll probably be able to appreciate my good fortune. After all, we share a common passion. I've always played games, whether they be sports, board challenges like chess or even Monopoly or, last but certainly not least, electro-mechanical machines and their descendants: electronic games.

Back in 1974, I had the opportunity to do a story on pinball machines. This proved to be the first in a string of events that finds me here today writing this column. My interest and fascination gave the energy necessary for the in-depth research and ultimate creation of *Pinball!*, a book which chronicled the history of a singularly unique and exciting industry. Doing the book, in turn, allowed me to meet and get to know the people behind the games. It came to be considered an authority on many different aspects of the business and found myself testifying in court cases such as the one involving the legalization of New York City pinball machines in 1976.

I began to write for industry trade publications and acted as a critic of sorts when new games were released before realizing a fantasy come true: designing my own pinball machine, *Sharpshooter* for *Game Plan* in 1979.

This brief personal saga and introduction aside, I am grateful to both Arnie Katz and Bill Kunkel for the chance to regularly bring you reviews of the new generation of pinball-

## Hot Trends in Coin-Op Pinball

By ROGER SHARPE

inspired machines. If you haven't noticed, lately, there's a lot going on with this worthy arcade attraction.

So far this year, the one observation which can safely be made, is that all the conventional rules have been broken regarding pinball game design. At no other time in the more than 50 years of

the machines' existence, have manufacturers offered the diverse variety of formats and game play-action seen today. Innovation is the watchword as manufacturers continue their quest to find the best way to lift pinball back into the spotlight. Some think they have succeeded just by daring to be different and producing the unexpected. See if you agree.

Last November, Williams caused quite a stir when it unveiled *Hyperball*, the creation of designer Steve Ritchie, an individual who had already made a profound impact on pinball with such efforts as *Flash*, *Firepower* with its multi-ball play and *Black Knight* which proved the games could provide yet another level of excitement. Housed in a pinball-style cabinet and using small ball bearings, *Hyperball* was initially looked upon as the next evolution for flipper games, even though it didn't feature any on screen bats and seemed inspired more by videogames.

### HYPERBALL

Williams

Although other companies have since introduced machines in the same vein (which we will be covering closer in upcoming issues), including Bally's March release of *Rapid Fire*, the hyperactive *Hyperball* is a breed apart. Wielding two Hyper-Cannon trigger mechanisms capable of firing 250 balls per minute, players must protect a mid-field Energy Center on a board featuring an array of dazzling red lightning bolts. Lettered target holes on either side of the playfield signal the



Pinball has shaken off its doldrums.



# LET 'EM KNOW YOU PLAY TO WIN!

Do you crave action and adventure, love fantasy, and gobble up thrills? Let everyone know exactly what your favorite hobby is. Show 'em all that you're plugged in to fun by wearing the ELECTRONIC GAMES T-shirt! Cool and comfortable, the T-shirts are soft grey with bright red printing and are made of first-quality 100% cotton. Washable, wearable, perfect for players who know the score!

## The electronic GAMES

# T SHIRT

The Top  
for Top  
Players:

only  
\$7.95  
each

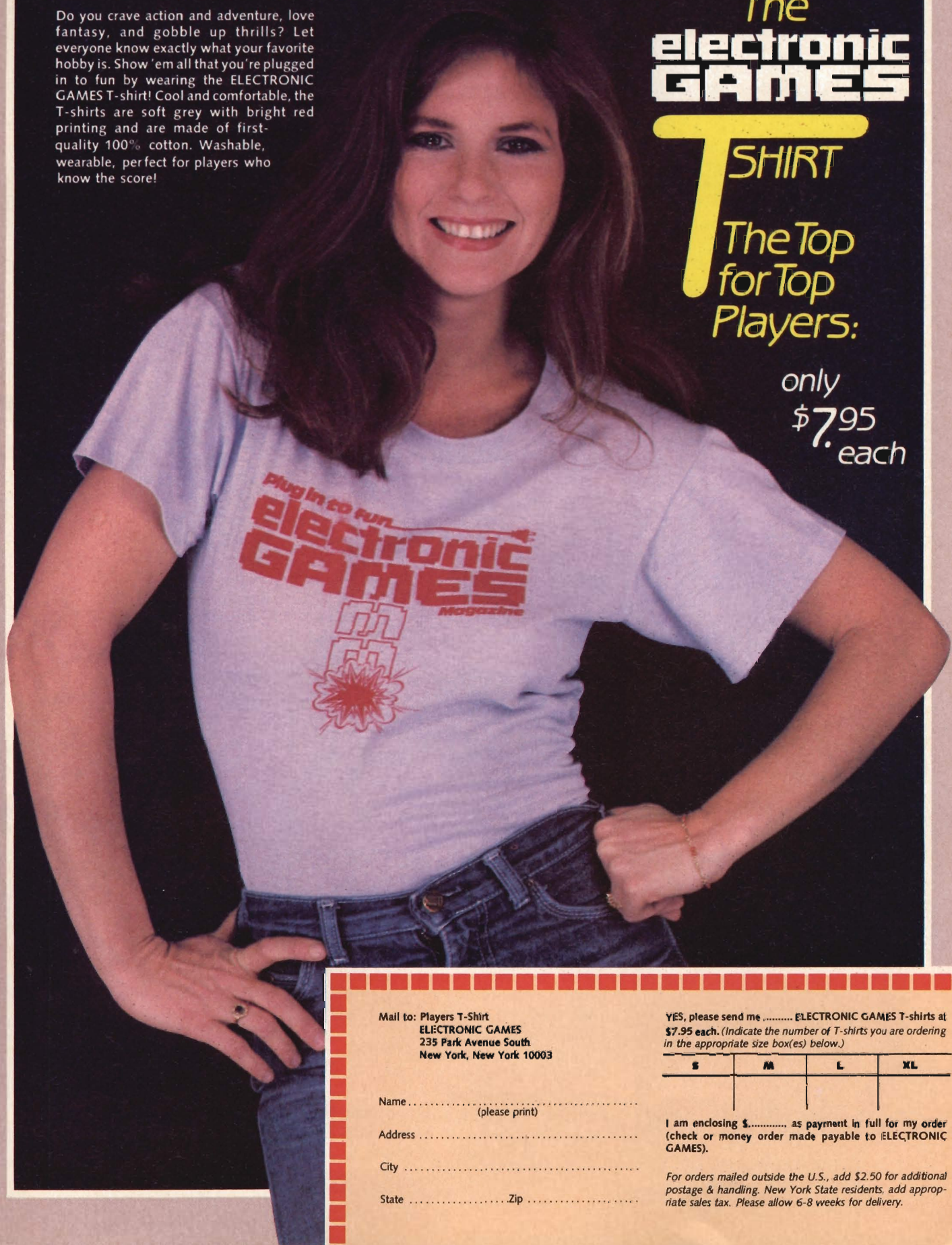

Mail to: Players T-Shirt  
ELECTRONIC GAMES  
235 Park Avenue South  
New York, New York 10003

YES, please send me ..... ELECTRONIC GAMES T-shirts at \$7.95 each. (Indicate the number of T-shirts you are ordering in the appropriate size box(es) below.)

S	M	L	XL

Name .....  
(please print)

Address .....

City .....

State ..... Zip .....

I am enclosing \$..... as payment in full for my order (check or money order made payable to ELECTRONIC GAMES).

For orders mailed outside the U.S., add \$2.50 for additional postage & handling. New York State residents, add appropriate sales tax. Please allow 6-8 weeks for delivery.



attack that can only be stopped by direct hits before reaching the top, at which point the lights turn into lighting bolts and begin their descent. An added challenge is the randomly appearing 'baiter', which weaves back and forth and must be destroyed at all costs.

*Hyperball's* non-stop action may seem fairly straight-forward, but there are nuances to consider if players want to maximize their scoring opportunities. Extended play is achieved by hitting a flashing letter target when it's specified on the game's alpha-numeric display, placed just below the field's Energy Center. Accomplishing this earns Z Bombs (a special part of the player's arsenal, which are detonated by a single red button between the two Hyper-Cannons. When pressed, the Z-Bomb eliminates all enemies on the playfield), Energy Units or Bonus Points. When a word is flashed on the display, and can be spelled out in sequence, the increases in values are even greater.

Knocking out 30 bolts completes an attack wave and awards a bonus equal to the number of remaining Energy Units multiplied by the number of waves completed, times 1,000, with an additional Energy Center and Z collected at every increment of 400,000 points. As if the action weren't already fast-paced enough, every fifth wave is a Special Reflex Wave. The target lights randomly and a rapidly decreasing score value is entered on the display. Hitting the target earns the total

Pinball machines introduced super-graphics to arcades.



that's shown and stops the countdown. There are 20 targets in this wave and, after the first five, failing to hit the next target in the time allotted will end the wave, while completing the sequence will get a player an added bonus.

Visually, *Hyperball* is exciting with its flashing red bolts on the playfield and the continual out-pouring of balls onto the table. In a way, it's similar to invasion-type videogames, where the attackers get closer and closer to that which must be protected. The on-board display enhances play by offering directions and warnings, as well as beautifully complementing sound effects which, all together, makes *Hyperball* a total entertainment package for both pinball and videogame players alike.

## CAVEMAN

Gottlieb

Long recognized for its rather conservative approach to game design and a corporate stance which championed pinball before players made their demands obvious regarding video, Gottlieb has answered the call with a line-up of innovative flipper machines and one effort which totally departs from the norm.

In a cabinet notable for its strikingly different backglass treatment, *Caveman* brings together both pinball and video in one game, without losing the essential qualities of either medium. The play is basically very simple to understand. The field looks conventional

enough at first glance, except for the presence of a slightly tilted (no pun intended) video screen at the top of the board.

Realizing that this initial creation, which combines pinball and video play, couldn't be so difficult as to turn-off either player, Gottlieb has chosen a safe format highlighted by a symmetrically balanced pinball board and a video portion incorporating a maze, with both having an impact on a player's overall success.

The layout takes advantage of a short plunger shot entry into mid-field where the main features are a top and bottom set of flippers, two banks of four drop targets, three thumper-bumpers in the middle and two long range vari-targets up the right and left side alleys. Access to the video part of the game is achieved by making either vari-target or landing behind the drop target banks, where play suddenly shifts to a center joystick control.

The strategy for *Caveman* is for players to strive to get to the portion of the game where they feel the most adept, although a majority of the rewards demand some amount of flipper skill. Spelling out C-A-V-E(which is split up on the left and right side at mid-field) will light the potential for an extra ball, but it can only be collected in the video maze.

The drop targets, meanwhile, are the source for bonus multiplier values from 2X to 5X of the score accumulated during the play of a particular ball. Here, the flashing lights just to the



Spanish Eyes, shown here, predates digital scoring.



Caveman blends pinball and videogame action.





side of the banks, denote which targets are needed for this increased value, while also influencing what will happen on the screen. Finally, the vari-targets feature an opportunity for players to lengthen their time when the action shifts to video.

At this point the little caveman gets into the act as players try to maneuver him around the maze in a quest to eat five Brontosaurus, Triceratops and Pterodactyls. When consumed, these dinosaurs quickly turn into red killer Tyrannosauruses. Complete a species and a new one appears along with increased values. Get killed in the process and that turn is over. Of course, a player can choose to escape by one of the doors on the screen which will once again return to pinball action.

So with *Caveman*, it's two for the price of one, and more than enough challenges to test the skills of the most ardent videophile or pinballer.

## MR. & MRS. PAC-MAN

Bally

It was bound to happen. The reigning cultural phenomenon of our time



Mr. & Mrs. Pac-Man is the latest addition to the family.

has spawned yet another off-shoot which Bally is hoping will appeal to pinballers who know the name, as well as videogame devotees ready for a markedly different type of action. Housed in a new cabinet design, **Mr. & Mrs. Pac-Man** doesn't just borrow on its name sakes and their popularity, but integrates the folk heroes into the basic play of the game which is pinball—plus a little bit more.

Incorporated within a rather conventional playfield design featuring a top area of two thumper-bumpers, a lone flipper and a three bank of drop targets, along with two sets of four drop targets fronting stand-ups at mid-field, is a center 25-light Pac-maze Vid-Grid which is at the heart of Mr. & Mrs. Pac-Man's play routine.

A digital readout, just above the bottom flippers, indicates "time to beat", "mazes completed" and "Pac-Man moves" with players qualifying and accumulating these values via the targets and lanes on the board.

Access to the maze itself, is possible via a long shot up the left side to a top kick-out hole (or "Pac-Man saucer" as it's called), or up the right side to another kick-out hole. This will activate the maze, where the strategy is to avoid the red light and maneuver the yellow light to complete the grid and advance to the next level.

Although this might sound fairly simplistic, a degree of difficulty is provided by the use of two flipper buttons on the left side. One controls the direction of movement and the other actually makes the moves. The inclusion of a joystick might have been a better choice since players must keep their eyes not only on the grid, but also on the directional arrows and digital display below.

However, *Mr. & Mrs. Pac-Man* is an interesting machine that attempts to offer a video-like quality of play without the screen. Whether players will make the translation remains to be seen, but the indication is that pinball design can, in fact, go beyond what were once thought of as very real boundaries to bringing new dimensions into the action and skill. All in all, the question remains—will Bally plan to continue promulgating the *Pac-Man* family with other issues that might bear more than a passing resemblance? The feeling here is that we've only seen the first of the offspring.

This said, players are going to have to determine not only if they like the upcoming *Pac-Man* relatives, but whether pinball in its diversity of design has hit some responsive chords with the playing public. One sure thing is that manufacturers will have to continue to upgrade and improve their products time and again.











## Lead the Electronic Army to Victory!

By JOYCE WORLEY

If you haven't been paying attention to the stand-alone gaming scene lately, you may still think that it's completely dominated by sports games and space shoot-outs. It is true that manufacturers have traditionally searched the skies for inspiration when not watching the country's sports arenas, but they've also discovered that there are other possibilities for useful and diverting devices.

This month's column concerns three innovative applications of computer technology. Designers have looked at the best that space-age electronics can produce and applied these exciting new advances to entertaining devices that would have been impossible until very recently.

And there's not a sports simulation nor space shoot-'em-up in the entire lot!

### ELECTRONIC STRATEGO

Milton Bradley/\$43-\$49

A battle rages on every side. Bombs explode as Miners use detecting instruments to chart enemy minefields. Scouts rush ahead of the main force, gathering the information needed to cross the battlefield. All around, brave men fight and sometimes die, trying to advance on this bloody field of combat. A spy in the ranks searches for the opposing Commanding General, bent on assassination. Nothing but capture

of the enemy battle standard will end this conflict.

**Electronic Stratego** is a prime example of what computer wizardry can do for a classic. Gamers who cut their teeth on Milton Bradley's boardgame *Stratego* will find this high-tech version greatly improved by sophisticated electronics.

The routine of play is largely unchanged from the original version. Two players control forces of 23 troops each plus a flag. The playing pieces represent military personnel of different ranks. Moving onto a square occupied by the opponent's piece pro-

duces conflict, and the most powerful piece prevails. The object is to capture the opponent's flag in order to win the battle and the game.

But there are important differences from non-electronic *Stratego*. In addition to the players on the board, each gamer controls a Secret Command Center, on which six bombs can be set up on spaces which correspond with the squares on the board. Each player sets up these explosive devices where they'll do the most good. When any of the opponent's pieces steps on a mined square, it is blown up. Only a Miner can disarm bombs without being destroyed.

Each army has five Scouts. This piece has been made extremely versatile in *Electronic Stratego*. The Scout is the only man who can move more than one square at a time. The Scout can travel horizontally, vertically or diagonally in a straight line, to any unoccupied square. The scout is unique in possessing the ability to move and attack on the same turn. In this new version, the Scout can also strike from a distance. The Scout remains in his space, while attacking at any piece which he could reach by regular movement. This avoids the risk of exposure to hidden bombs.

On any turn, a player may elect to probe for information instead of moving. Each player has an electronic

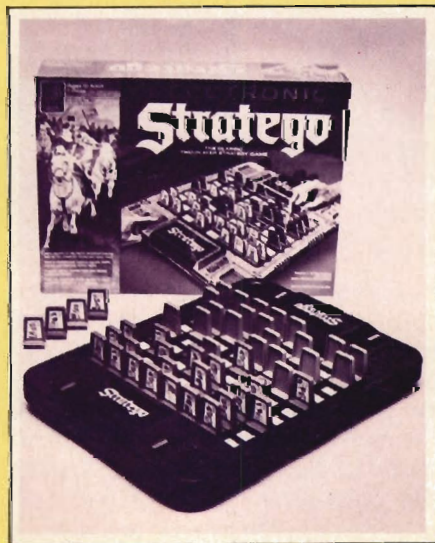

ELECTRONIC STRATEGO



probe device. Press this key, then the piece in your opponent's rank which you want to identify. The machine responds with one, two or three beeps and corresponding lights, to indicate the class of the piece. The Commanding General, General, Colonels, Majors, Spy and the Flag are all Class 1 pieces. Class 2 is made up of the Captains, Lieutenants, and Sergeants. Scouts and Miners are Class 3 pieces. A convenient chart on the inside of the door to each Secret Command Center reminds players of the value and class of each piece.

*Electronic Stratego* is played on a pressure-sensitive board, and each piece is coded with a pattern of plastic nodes on its base. Pressing the piece against the sensitive board informs the computer of the rank and position of the officer in question. The player moves the piece to the desired square,

sault. Press down the enemy piece, and another drum roll answers back.

Then the computer magic takes over. The microprocessor decides all combat, based on the rank of each piece involved in the conflict. If your piece outranks the enemy piece, your red light flashes and a victorious trumpet sounds. If you lose the attack, the opponent's red light flashes to indicate he has won, and a dirge mourns the death of your man. In case of a tie, both players' red lights flash, while the funeral hymn informs that both sides have gone to the great battlefield in the sky.

Since the computer keeps track of all the pieces on the board and decides all conflicts, it's never necessary to reveal the identity of any piece. Beginning players may wish to do so, however, in order to make the game easier. In fact, the rule book suggests varying the dis-

no ranks are ever announced, neither the winner of a strike nor the captured piece.

It is in fact this particular element of *Electronic Stratego* that most easily distinguishes it from its non-electronic predecessor. In *Stratego*, it is necessary to reveal the identity of both pieces engaged in conflict. After a few moves, memory and logical deduction can remove the suspense from the game, but computer circuitry has changed all that.

A variety of musical interludes, battle sounds and lights enhance the game. Stirring marches fan the flames of battle, while dirges mark the passing of each brave soldier felled in conflict. Bombs announce their presence with a descending whistle and long explosion, followed by the mournful music signaling the death of the unlucky warrior. Capture of the Flag is hailed by special victory salutes and, the *1812 Overture*.

The instructions accompanying the game stress that only a soft touch is needed to activate the pressure-sensitive playing board. Actually, you'll have to use a fairly hard push. This is important, since failure to properly enter the moves can lead to the computer giving mistaken results in conflicts. But a firm touch solves all the problems.

*Electronic Stratego* is a fine electronic boardgame. It gets my vote for the most pleasant little war I've ever fought!

## TC-7 AIR TRAFFIC CONTROL

Bandai America, Inc./\$55

Bandai's *TC-7 Air Traffic Control* trims the thrill of the flight lanes to stand-alone size, with a most unusual application of high-tech creativity. Arcaders guide planes from takeoff into the wild blue yonder, or through approach patterns to a safe landing. A variety of hazards, ranging from mid-air collisions to running out of fuel, threaten the intrepid pilots. The gamer must safely shepherd the aircraft in and out of the heavily trafficked airways.

*Air Traffic Control* is a well-designed stand-alone unit. The control panel is a touch-sensitive monoplane keyboard with range of 20 separate inputs. This is one of the most complex miniature marvels yet designed for gamers. The display screen above the control panel provides the map of flight paths for arriving and departing aircraft, as well



then presses it against the board. A drum roll signals that the computer has noted the move.

If a piece begins the turn in fighting position, that is, adjacent to any opponent's piece, it may strike. Press the strike button and a military *Charge!* issues from the speaker. Press the attacking piece in its square, and a drum roll signals the beginning of the as-

closure of playing pieces' ranks after a strike in order to produce different skill levels. In the easiest method of play, both the winning and captured pieces are announced aloud after a battle. At the second skill level, the rank of the captured piece is announced, but not the victor's rank. More experienced players will probably wish to utilize the more challenging level of play in which



# What Has Your TV Set Done For You Lately?

Sure, watching "the tube" is enjoyable a lot of the time. But today, home entertainment is much more than just broadcast TV. Today, your TV set can bring you movies you choose yourself to play any time you like. Fun and games. Problem-solving, self-improvement, and personal security. Unique, priceless memories of family and friends. Art you create yourself. It's a whole new world . . . the fascinating world of video.

Whether you're a video veteran, a beginner just getting your feet wet, or someone intrigued with the thrilling possibilities the field offers now and for the future, VIDEO Magazine should be your guide to this world.

Every month, VIDEO will show you how to use your TV, not just watch it. You'll read news of and invaluable test reports on the latest video equipment. You'll find sources, previews, and reviews of pre-recorded programs to buy or rent. You'll learn helpful home taping techniques: using a video camera, lighting, dubbing in audio, creating video art. You'll profit from expert technical advice. You'll explore all the alternatives to broadcast TV available today and the developing technologies coming tomorrow.

In short, you'll enjoy the most comprehensive information possible from the first and foremost video publication—and in a lively, thoroughly entertaining way.



## VIDEO

It's worth watching every month!

Use this coupon to enter your subscription . . . or pick up the latest issue at your favorite newsstand

Mail to: VIDEO  
Subscription Department  
P.O. Box 1118  
Dover, New Jersey 07801

YES! Please enter my subscription to VIDEO and send me 1 year (12 issues) at the regular subscription rate of \$15. (I'll be saving \$6 on the newsstand price of \$21.)

Name \_\_\_\_\_ (please print)

Address \_\_\_\_\_

City, State, Zip \_\_\_\_\_

My payment of \$15 is enclosed (check or money order made payable to VIDEO)  Bill me later

Offer good for the U.S. only. Please allow up to 60 days for delivery of first issue.

8EGA28



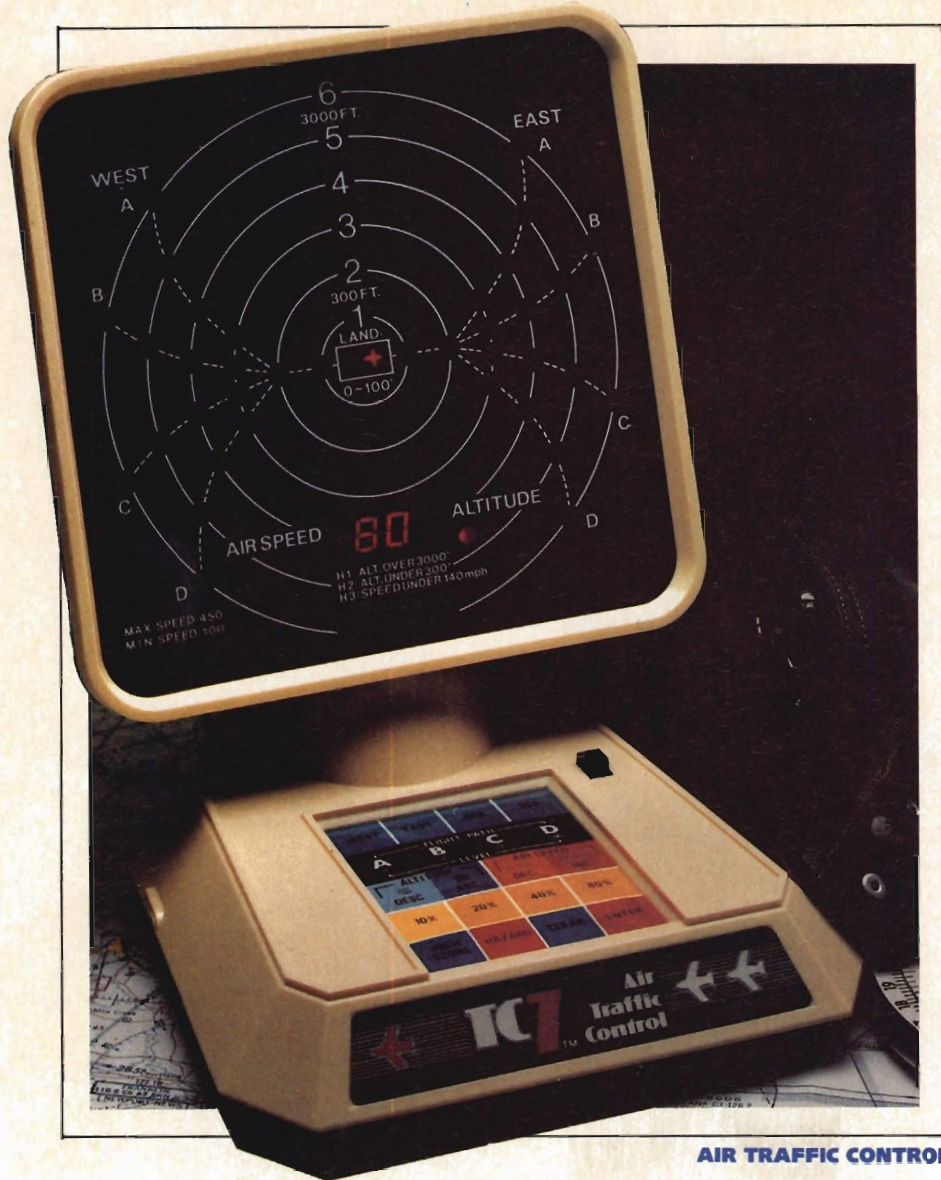

**AIR TRAFFIC CONTROL**

as air speed and altitude indicators.

Arcaders choose from four skill levels. Each has roughly 13 minutes of playing time in which controllers must accomplish the task assigned to the specific level. At the simplest setting, the gamer must make one successful takeoff and landing. At the most difficult level, the player guides eight incoming and five departing flights. All gamers start with a score of 9. Each skill level is allotted time in which to accomplish the required takeoffs and landings, ranging from 4 minutes for level A, to 11 minutes for level D. One point is deducted from the starting score for each minute used over the allotted time, and for each plane that plows into the runway or surrounding countryside.

It is unlikely that any arcader will be able to sit down and successfully play this game without reading the instructions. A typical takeoff requires the use of as many as 14 separate keys in the

proper sequence. Landings are even more difficult, requiring the player to key 20-25 instructions into the microprocessor in order to successfully set the ship down on the runway.

Fortunately, the rules booklet that accompanies the game is concise and well-written. Learners should have no difficulty following the precise directions. After a few practice runs with the book in hand, it'll all fall into place. The arcader should then be able to maneuver the plane using logic and acquired skills.

There are no brilliant flashing lights or screaming arcade sounds to reward the successful controller. The display is not animated in normal arcade fashion, though planes are indicated with red lights that show up well on the midnight-blue screen. Failure of a maneuver is preceded by warning sounds, then followed by a raspberry when the plane crashes. Yet to the gamer accustomed to the rich sounds

and lights of an arcade, *Air Traffic Control* may seem sedate.

This is largely a cerebral game, challenging the player's mental, as opposed to physical, agility. Any gamer who lands eight planes and launches five more in the allotted 11 minutes certainly deserves to feel proud.

## **TARO, THE MYSTIC CARD READER**

*Fidelity Electronics/\$50*

Fidelity Electronics has made the endless search for tomorrow a bit easier with its introduction of **Taro, the Mystic Card Reader**. This computerized muse will divine your past, present and future, and gives advice how to draw nearer to your heart's desire.

*Taro* applies space-age technology to unraveling the wisdom of the ancients. A combination of Astrology, Kabbalah and Tarot is coupled with a microprocessor. The result will amuse and/or instruct everyone who's interested in the occult.

A torso of a swami houses the games inner workings, with an entry portal in the base of the statue for insertion of the fortune telling cards. Readings appear in the LCD window just above the portal, once all the data is entered into the computer.

In the past, those wishing advice from a seer had to face arduous, sometimes dangerous, journeys. Once face-to-face with the prophet, the ancients risked catching the fortune teller on a bad day and facing his or her traditionally bad temper. Even if the mystic was in a good mood, there was no assurance that the message would be understandable to the supplicant.

The easy-to-operate *Taro* takes all the uncertainty and discomfort out of prophecy. Insert the astrology card with your Zodiac sign into the entry slot. Shuffle the deck of prediction cards, insert ten into the slot, and wait for the magic to begin appearing in the display window.

The readings are lengthy and more detailed than a trip to the usual carnival palmist or card reader. Each is made up of nine factors: 1) The current influences on your personality; 2) Your destiny; 3) Major factors of your past; 4) Near future events which will occur; 5) Future influences on your behavior; 6) Results of your next decision; 7) Your influence on others; 8) Your subconscious wishes; 9) The ultimate prediction for your future.

Here's what *Taro* had to tell me: "At



this time your life is marked by intrigue and conspiracy. Your destiny leads you to confusion and trouble. Love is deeply rooted in your past. You have had very recently, or are about to have, meaningful news. Power will soon play a major part in your life. The next decision you make will be generous and kind. Your influence on others is practical. One of your secret hopes is to end in justice. The final result of all these influences is originality and creativity."

After this nine-sentence reading, many will be chomping at the bit to know more, yet the instructions that come with *Taro* say owners should question the prophet about long-range prospects once each lunar cycle. Those who need more guidance than this from the sage, can obtain a daily reading. Once again I insert the astrological and prediction cards, this time adding a day-of-the-week card, to obtain my 24-hour prediction.

The daily forecast is comprised of five factors: 1) Evaluation of your physical and emotional abilities; 2) Evaluation of your performance; 3) Suggestion for conduct; 4) Suggestion for decision; and 5) Special insight message. This is what *Taro* told me today: "Your stamina is at its peak today. Your generosity will be appreciated. Think seriously about appearance. Be discreet." After the four-sentence reading, the supplicant can make one inquiry requiring an affirmative or negative answer. I asked, "Will my editor like this review?", and *Taro* replied, "You control the answer."

*Taro* comes with a deck of 22 pre-

diction cards, the astrological and day-of-week cards, and one question card. These ingredients are combined into many variations by the micro-processor, and it seems unlikely that two readings could ever be the same.

While the prophecies leave little to be desired, the unit is not without flaws. First is its appearance. It looks like an incense burner from the dime store. While nothing is intrinsically

wrong with the bust of a swami, it's made of plastic that is beneath the quality of housing expected from Fidelity products. A more prepossessing casing would've improved *Taro*, even if it cost a little more.

Two additional controls would make *Taro* easier to use. A repeat button, so the seer's words could be seen again, would relieve the problem of the prophecies being a little hard to read. Alas, the fortune-teller doesn't repeat himself. Secondly, a "clear" button would come in handy for those times when the operator makes a mistake in entering information. This would save the supplicant having to either complete the entire maneuver, including getting the reading based on the mistaken data, or waiting for the unit to shut itself off and start a new round.

The entry portal is a little tight. Sometimes there's difficulty inserting a card if it's at a slight angle. On the other hand, *Taro* gives a count in the readout window of the number of cards inserted, so there's never any question whether the data has been entered.

The worst problem is that the device makes no provision for storage of the cards. There should have been a place, even if it were just a simple pressure clip, in the bottom or back of the unit.

But these are minor quibbles and of no serious consequence. The fact is that *Taro* is unique and amusing.

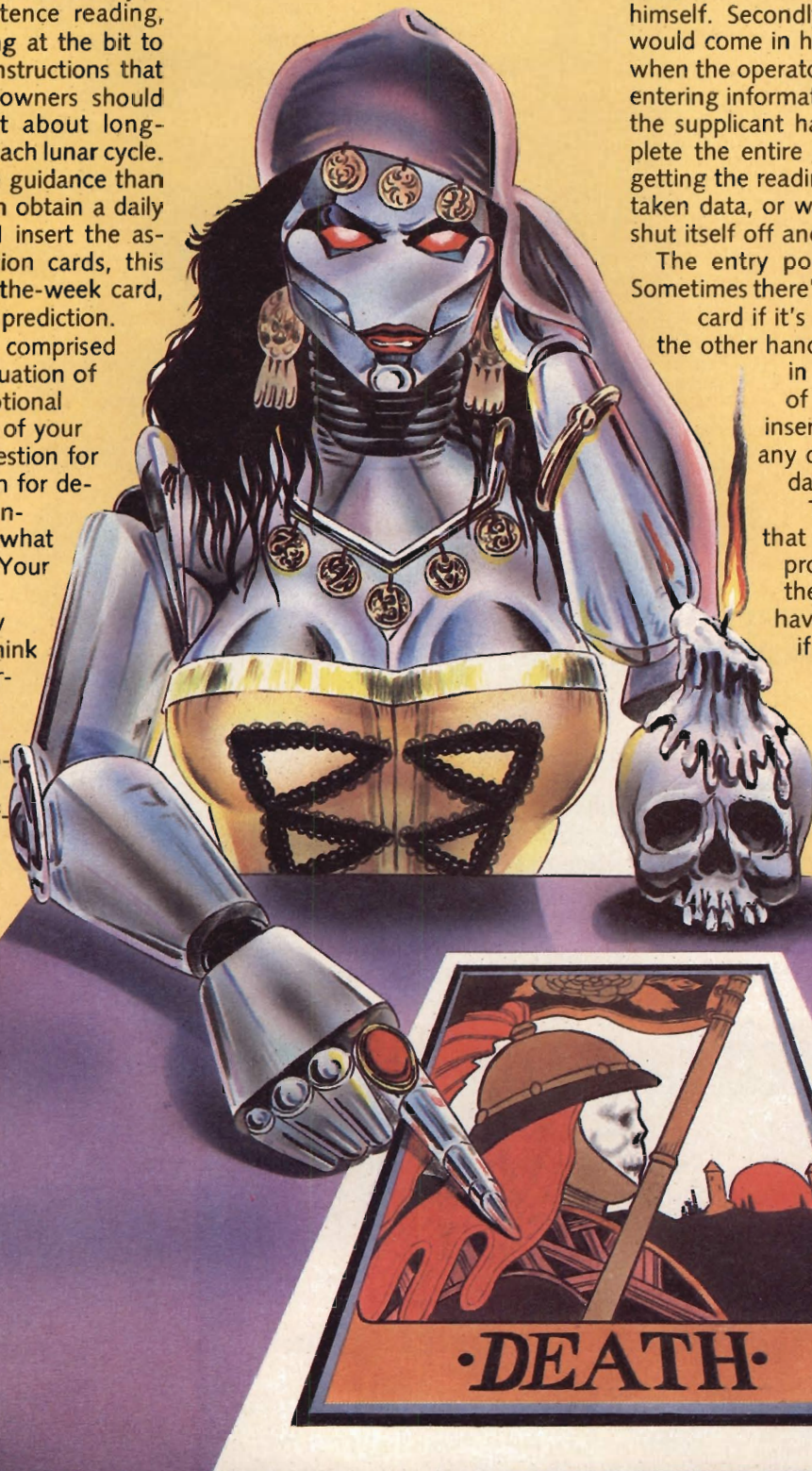



# SUBSCRIBE TO electronic GAMES



# We're HOT!

**We've got everything  
you want every month!**

Previews of the newest, best, most challenging games! Reviews of the latest gaming equipment! The valuable playing strategy you need to score higher, win more often, and blast the opposition! Special guided tours of the country's most exciting commercial arcades! Fun-filled features on all aspects of your favorite hobby! Answers to your gaming questions! And much, much more!

Use this coupon if ELECTRONIC GAMES order card is missing

Mail to: ELECTRONIC GAMES  
Subscriber Services  
P.O. Box 1128  
Dover, New Jersey 07801

No "dragon"  
your feet!  
**SUBSCRIBE  
NOW & SAVE**



**YES! I want to subscribe to ELECTRONIC GAMES!**

- Send me 12 issues (1 year) for \$28 (I save \$7.40 on the newsstand cost)  
 Increase my savings! Send me 24 issues (2 years) for \$48.00 (I save \$22.80)

Name .....  
(please print)

Address .....

City ..... State ..... Zip .....

- Enclosed is my payment of \$ .....  Bill me later

For Canada: 12 issues, \$32, U.S. funds. For all other countries: 12 issues (Air Mail only delivery), \$64, U.S. funds. Please allow up to 60 days for delivery of your first copy.



# READER POLL

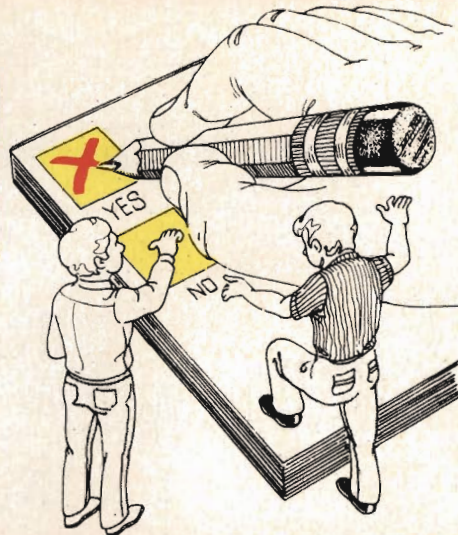

Interaction between the readers and editors of **Electronic Games** helps make this a better magazine. The more we here at **EG** know about who you are and what you want to read, the better we can satisfy your needs and desires. That's why we run a Reader Poll in every single issue of this

magazine. Rest assured that, even though we protect the anonymity of every respondent to our survey, the editor personally reads each and every ballot received. And of course, this is also your ballot for casting your vote for the most popular videogames, computer game programs and coin-op

arcade machines.

Please return this poll sheet—or a photocopy if you prefer to keep your **Electronic Games** in perfect condition—to: Electronic Games, 235 Park Avenue South, New York, N.Y. 10003.

Sex: Male \_\_\_\_\_ Female \_\_\_\_\_

Age: Under 14 \_\_\_\_\_ 15-17 \_\_\_\_\_ 18-19 \_\_\_\_\_ 20-21 \_\_\_\_\_  
25-29 \_\_\_\_\_ 30-34 \_\_\_\_\_ 35-44 \_\_\_\_\_ 45+ \_\_\_\_\_

Household Income:

Under \$5000 \_\_\_\_\_  
\$5000-9999 \_\_\_\_\_  
\$10,000-14,999 \_\_\_\_\_  
\$15,000-19,999 \_\_\_\_\_  
\$20,000-24,999 \_\_\_\_\_  
\$25,000+ \_\_\_\_\_

Marital Status: Single \_\_\_\_\_ Married \_\_\_\_\_

Number of Children in Household:

Ages:  
Under 2 \_\_\_\_\_  
6-11 \_\_\_\_\_  
12-17 \_\_\_\_\_

Please rate the following features from 1 (awful) to 10 (great):

Switch On! \_\_\_\_\_ Q&A \_\_\_\_\_ Test Lab \_\_\_\_\_ E.G. Hotline \_\_\_\_\_

Computer Playland \_\_\_\_\_ Programmable Parade \_\_\_\_\_

Insert Coin Here \_\_\_\_\_ Strategy Session \_\_\_\_\_

Arcade America \_\_\_\_\_ Passport to Adventure \_\_\_\_\_

Inside Gaming \_\_\_\_\_ Stand-Alone Scene \_\_\_\_\_

Players Guide \_\_\_\_\_

How many hours per week do you spend playing various types of electronic games:

Less than 2 hours \_\_\_\_\_ 2-5 hours \_\_\_\_\_ 6-10 hours \_\_\_\_\_  
More than 10 hours \_\_\_\_\_

How much do you spend per week on electronic games:

Under \$2 \_\_\_\_\_ \$2-5 \_\_\_\_\_ \$6-10 \_\_\_\_\_ Over \$10 \_\_\_\_\_

Please rate the following subjects from 1 (not very interesting to me) to 10 (of great interest to me):

Fantasy & Science Fiction \_\_\_\_\_ Sports \_\_\_\_\_ Wargames \_\_\_\_\_

Coin-op games \_\_\_\_\_ Videogames \_\_\_\_\_

Computer games \_\_\_\_\_

My favorite videogame cartridges are:

1. \_\_\_\_\_
2. \_\_\_\_\_
3. \_\_\_\_\_

My favorite microcomputer game programs:

1. \_\_\_\_\_
2. \_\_\_\_\_
3. \_\_\_\_\_

My favorite coin-op games are:

1. \_\_\_\_\_
2. \_\_\_\_\_
3. \_\_\_\_\_





# COMING NEXT IN **electronic GAMES**

## **THE GUIDE TO GAMING ACCESSORIES**

Manufacturers are beating their brains to come up with all manner of play-enhancing gizmos for arcade addicts. Next month, **EG** shows some of the most interesting new accessories so you can begin making up holiday lists.

## **THE PLAYERS GUIDE TO GAMING MICROCOMPUTERS**

The price of small computers keeps falling even as the machines themselves get more and more powerful. As a result, many arcaders who started with a videogame system are now looking to expand their gaming horizons with one of the popular micros. This magazine-within-a-magazine will provide a complete rundown on the most popular machines as well as the best software available for each.

## **DIAL-A-GAME**

Interactive gaming thrills are just a phone call away, if you're a member of Gamemasters, the computer network that links game-lovers from coast to coast.

## **KING OF THE STAND-ALONES**

It's called the Vectrex, and it represents an entirely new generation of stand-alone electronic games. Built around its

own vector graphics monitor, Vectrex features graphics right out of the coin-op amusement centers.

## **TRON: THE COIN-OP**

Never before has any magazine unveiled the behind the scenes story of the creation of a major coin-op videogame. Now **EG** tells you all about the secrets, the triumphs and the frustrations on the way to creating Midway's **Tron** machine.

**There'll be plenty of other exciting articles and features of interest to arcaders, plus these regular columns:**

- |                                |                         |                              |
|--------------------------------|-------------------------|------------------------------|
| ★ <b>Passport to Adventure</b> | ★ <b>Switch On!</b>     | ★ <b>Stand-Alone Scene</b>   |
| ★ <b>Q&amp;A</b>               | ★ <b>New Products</b>   | ★ <b>Mini-Arcade Gallery</b> |
| ★ <b>Inside Gaming</b>         | ★ <b>Test Lab</b>       | ★ <b>Coin-Op Classroom</b>   |
| ★ <b>Arcade America</b>        | ★ <b>Readers Replay</b> | ★ <b>Strategy Session</b>    |
| ★ <b>Computer Playland</b>     | ★ <b>EG Hotline</b>     | ★ <b>Insert Coin Here</b>    |
| ★ <b>Programmable Parade</b>   | ★ <b>Games Library</b>  | ★ <b>Pinball Palace</b>      |

So watch for the  
exciting **NOVEMBER** issue  
of **ELECTRONIC GAMES**  
**On Sale**  
**October 12, 1982**

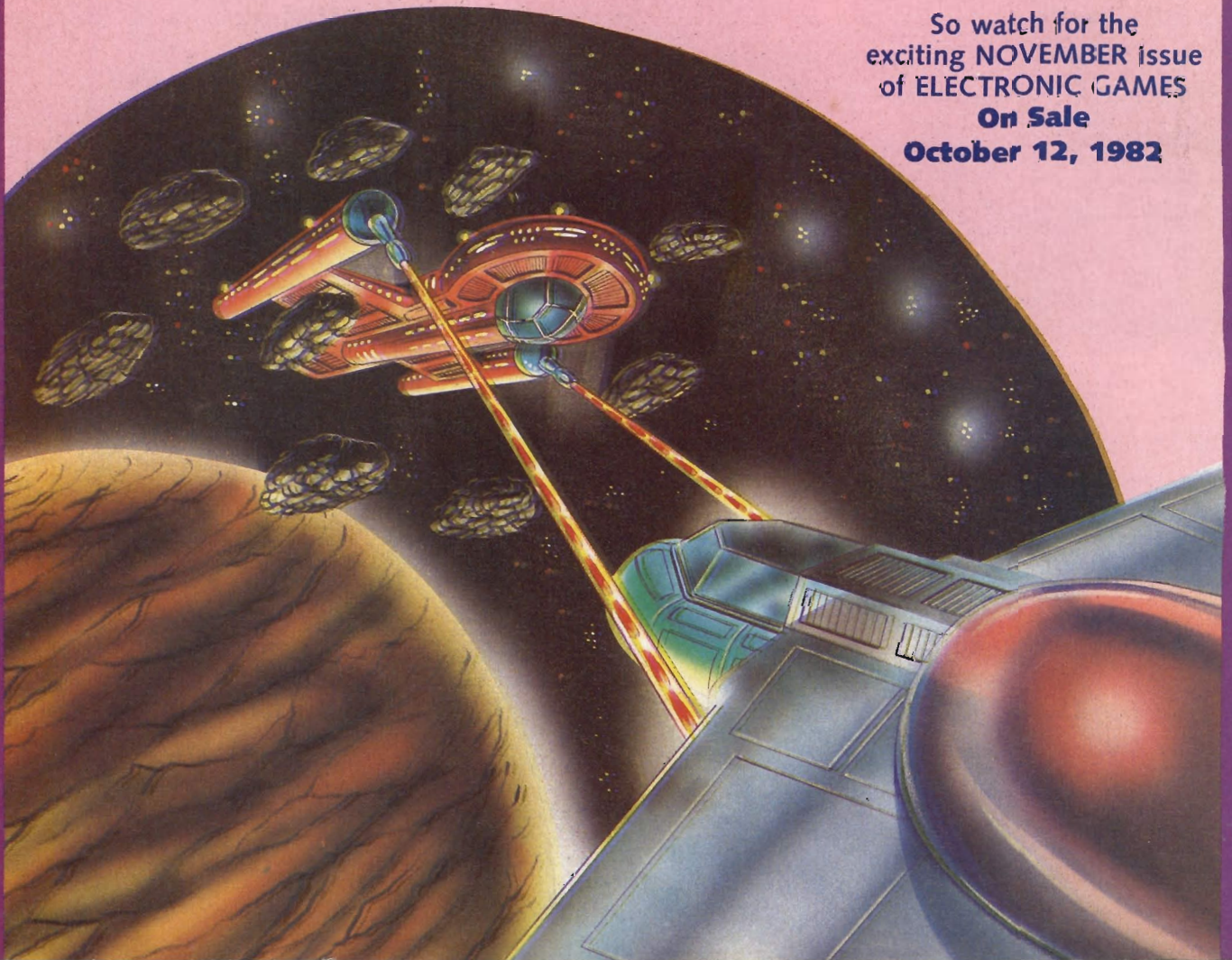





# THE WIZARD OF ODYSSEY REVEALS THE KEY TO GREATER CHALLENGE.

*The Keyboard!*

*It makes the fun go further with Odyssey<sup>2</sup> than any other video game. The keyboard lets you program mazes and grids. Type numbers and letters on the screen. Increase skill levels. It even lets you change opponents and fields of play!*

*And only Odyssey<sup>2</sup> offers—The Master*



*Strategy Series™!*  
*Each game comes with its own game board. You use it to plan your strategy,*

*input that strategy through the keyboard, and play out the action on your TV screen.*

*Plus, Odyssey<sup>2</sup> offers over 50 games, including arcade, educational, sports and strategy games.*

*So take the word of the Wizard of Odyssey. If you're looking for greater challenge in a video game, look to Odyssey<sup>2</sup>! For your nearest dealer call (800) 447-2882. In Illinois call (800) 322-4400.*

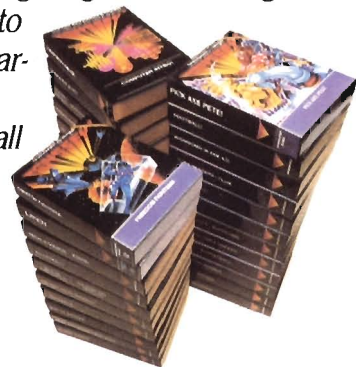

## ODYSSEY<sup>2</sup>

*The keyboard is the key to greater challenge.*



# "DON'T BE ANOTHER STATISTIC!"

—Pitfall Harry,  
Veteran Jungle Guide

## KNOW THE DANGER SIGNS OF PITFALL!™

This year thousands of jungle explorers will join Pitfall Harry and seek lost treasures in Pitfall!™ by Activision®. A new video game for use with the Atari® Video Computer System™. Ultimately, thousands of jungle explorers will also fall prey to the many hazards found in Pitfall's maze.

Therefore, Activision urges you to prepare yourself for some very unusual video game dangers.

For example, you and Harry will swing on a vine over crocodile infested swamps. Climb down into dark underground passages. Traverse tar pits, quicksand and vanishing bogs. And even leap over scorpions, rolling logs, open mine shafts, fires and deadly cobra rattlers. So please be careful when you play Pitfall!™ by Activision®. Because every step you take, could be your last.

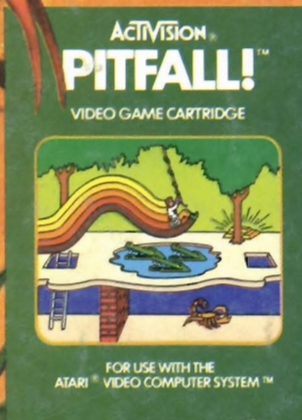

**ACTIVISION®**  
WE PUT YOU IN THE GAME.

Designed by David Crane.

Atari® and Video Computer System™ are trademarks of Atari Inc. Also for use with the Sears Tele-Games® Video Arcade™. Tele-Games® and Video Arcade™ are trademarks of Sears, Roebuck & Co.

©1982 Activision, Inc.